



VERSA-MATIC®

DELIVERING QUALITY, INTERCHANGEABLE PUMPING SOLUTIONS



Metallic Bolted



Metallic Clamped



Non-Metallic Bolted



Special Applications



Accessories



VERSAMATIC.COM
AIR OPERATED DOUBLE
DIAPHRAGM PUMPS

THE VERSA-MATIC ADVANTAGE

Versa-Matic® exclusively offers the revolutionary Elima-Matic® air distribution system, which virtually eliminates pumping problems and ensures that your operations run smoothly.

The high quality of Versa-Matic pumps, combined with the Elima-Matic air distribution system delivers an optimum AODD pump experience.

- Reliable Performance**
 Elima-Matic pumps are designed to reduce downtime by ensuring continuous, reliable pump performance.
- Ease of Maintenance**
 Versa-Matic pumps have been specifically designed to make maintenance simplified and cost effective.
- Elimination of Downtime**
 The Elima-Matic air distribution system ensures continuous, reliable pump performance.
- Maximized Pumping Performance**
 Versa-Matic pumps can handle anything from water to 90% solids easily and effectively.
- Global Distribution and Support**
 Our industry leading distribution network provides you expert solutions, convenience and support.

Versa-Matic® is committed to delivering quality interchangeable pumping solutions without compromising your budget.

ABOUT US

Since 1983, Versa-Matic has redefined the standard of performance in air operated double diaphragm (AODD) pumps. Versa-Matic AODD pumps provide high quality and the best value for your fluid transfer needs. These dimensionally interchangeable products are the first choice for replacement upgrades. Learn more at versamatic.com/about.asp.

Versa-Matic Fast Facts:

- World Headquarters : 800 N. Main St. • Mansfield, Ohio
- Established : 1983
- Technology : Air Operated Double Diaphragm
- Global Support : Coverage on all 7 continents
- Global Coverage : Pumps on all 7 continents with diverse industries & applications
- Reliability : Over a half million pumps sold
- Phone : +1 419.526.7296
- Fax : +1 419.526.7289
- Website : versamatic.com

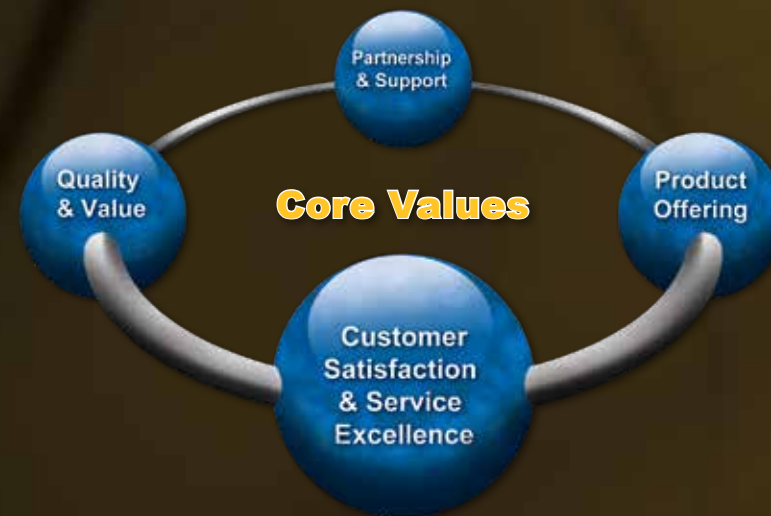

TABLE OF CONTENTS

- About Us.....2-3
- Applications & Industries4-5
- Installation Versatility..... 6
- How it Works..... 7
- Air Distribution System..... 8
- Why Choose AODD Pumps 9
- Features & Benefits..... 10-11
- Interchangeability..... 12-13
- Pump Model Codes14-15
- Pump Models
 - Metallic Bolted 16-21
 - Metallic Clamped.....22-25
 - Non-Metallic Bolted.....26-30
 - Special: FDA32-35
 - Special: 3A Hygienic36-37
 - Special: High Pressure..38-40
 - Special: Centrifugal.....42-43
- Accessories44-47
- Diaphragm Selection.....48-49
- Materials of Construction 50
- Technical Information 52
- Genuine Parts54-55



APPLICATIONS & INDUSTRIES

Versa-Matic provides the pumps that move your industry.
Installed in hundreds of applications and industries throughout the world.

Manufacturing

Military

Mining

Food & Beverage

Energy

Paints & Coatings

OEM

Construction

Distribution

Pharmaceuticals

Chemical Refining

Marine

Ceramics

Transportation

Oil & Gas

Textiles

ONLY A SAMPLING OF INDUSTRIES SERVED

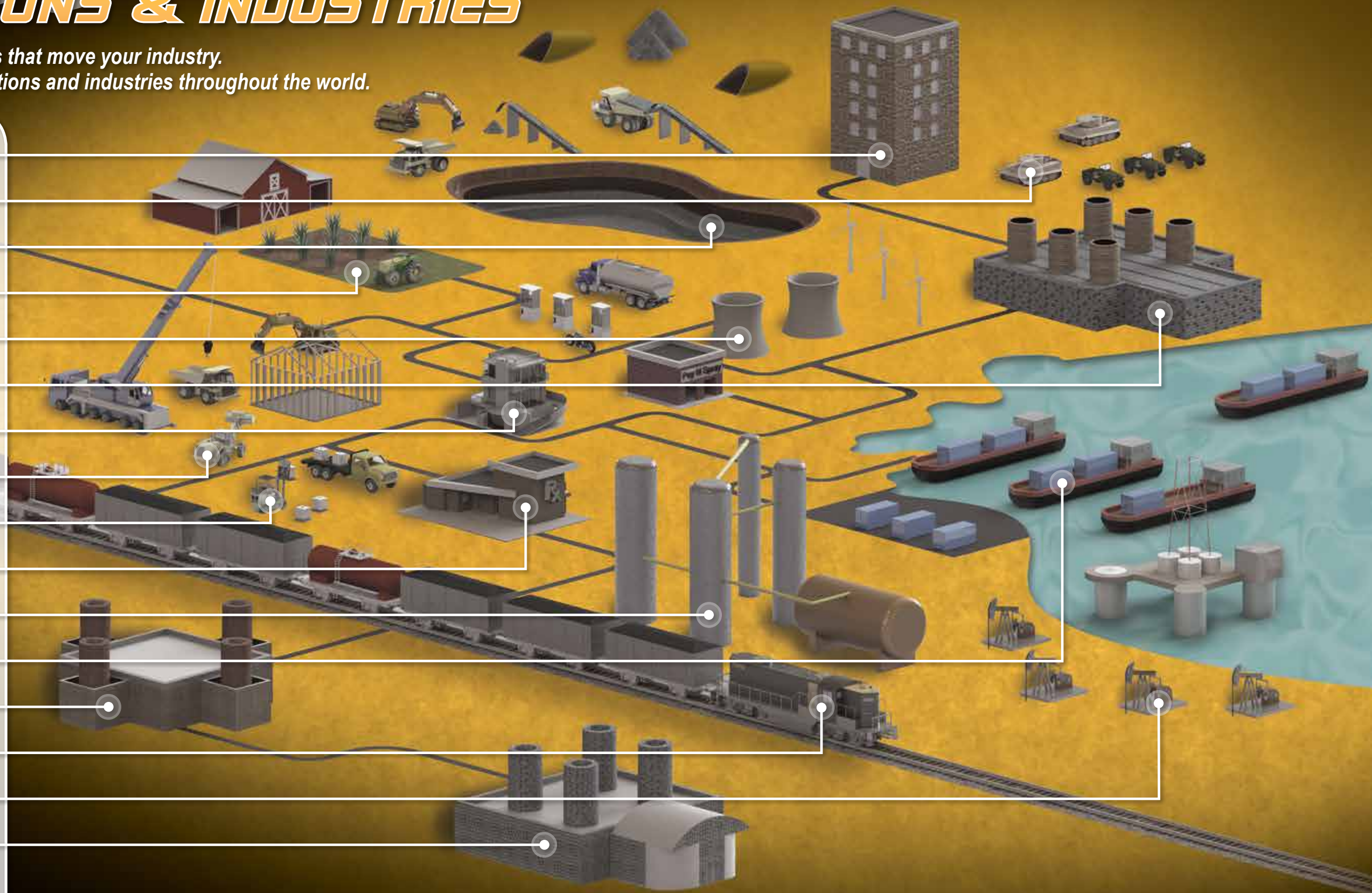

INSTALLATION VERSATILITY

Versa-Matic installation and application flexibility is unrivaled compared to other types of positive displacement (PD) pumps. Our pumps are designed to perform in less than optimum system conditions. Versa-Matic pumps can be fixed mounted to your process system or remain portable for easy mobility. Simplifying your systems begins with Versa-Matic.

All installations: • Run-dry capable • No heat generation • No electricity required

Suction Lift

- Self-priming
- High vacuum capable
- Max lift of 32' (9.8m)

Submerged

- Capable of full submersion
- Screened inlet option

Flooded Suction

- Preferred for viscous fluids
- Most common application
- Screened inlet option

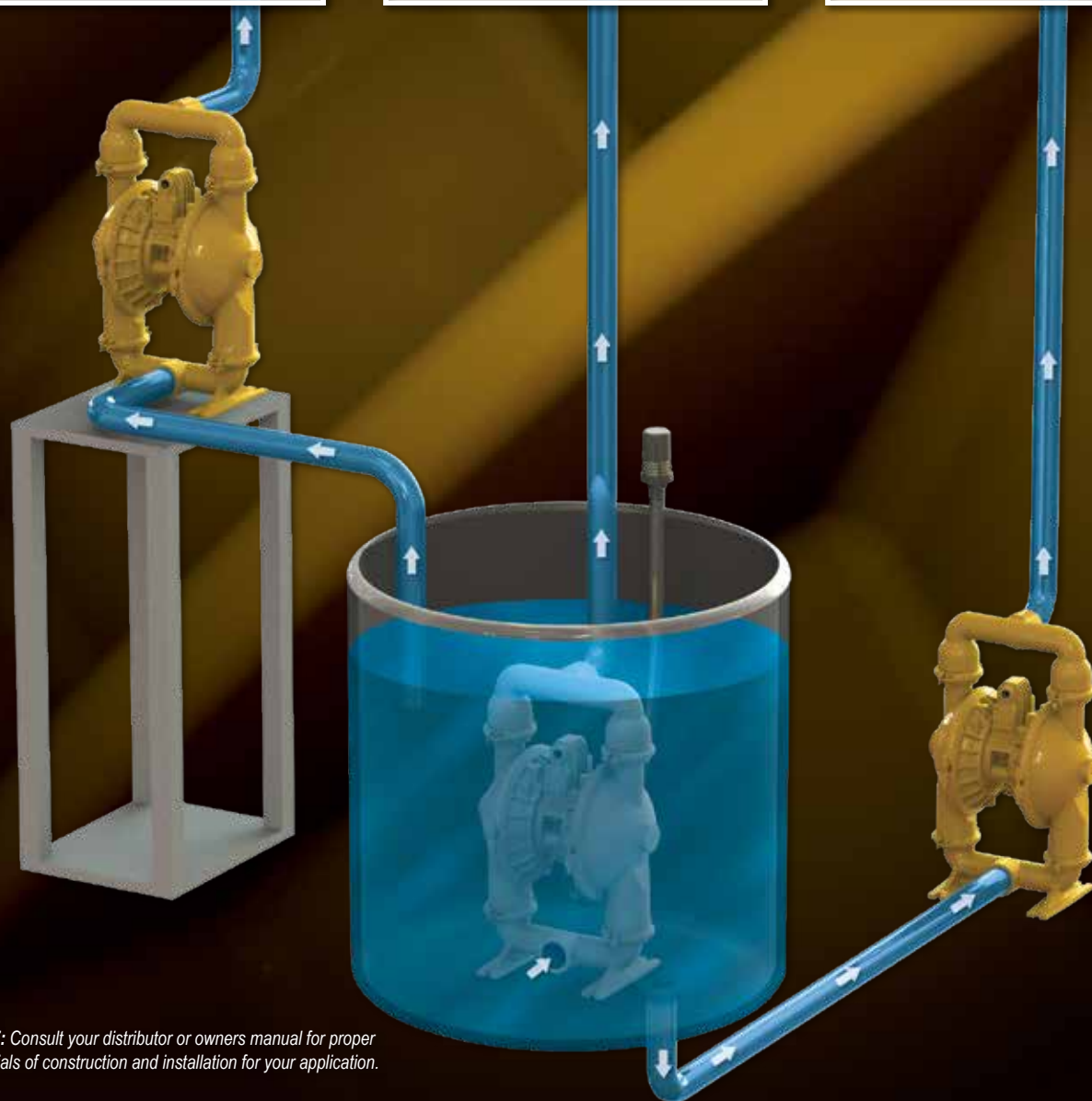

NOTE: Consult your distributor or owners manual for proper materials of construction and installation for your application.

HOW IT WORKS

■ = Compressed Air ■ = Pumped Fluid

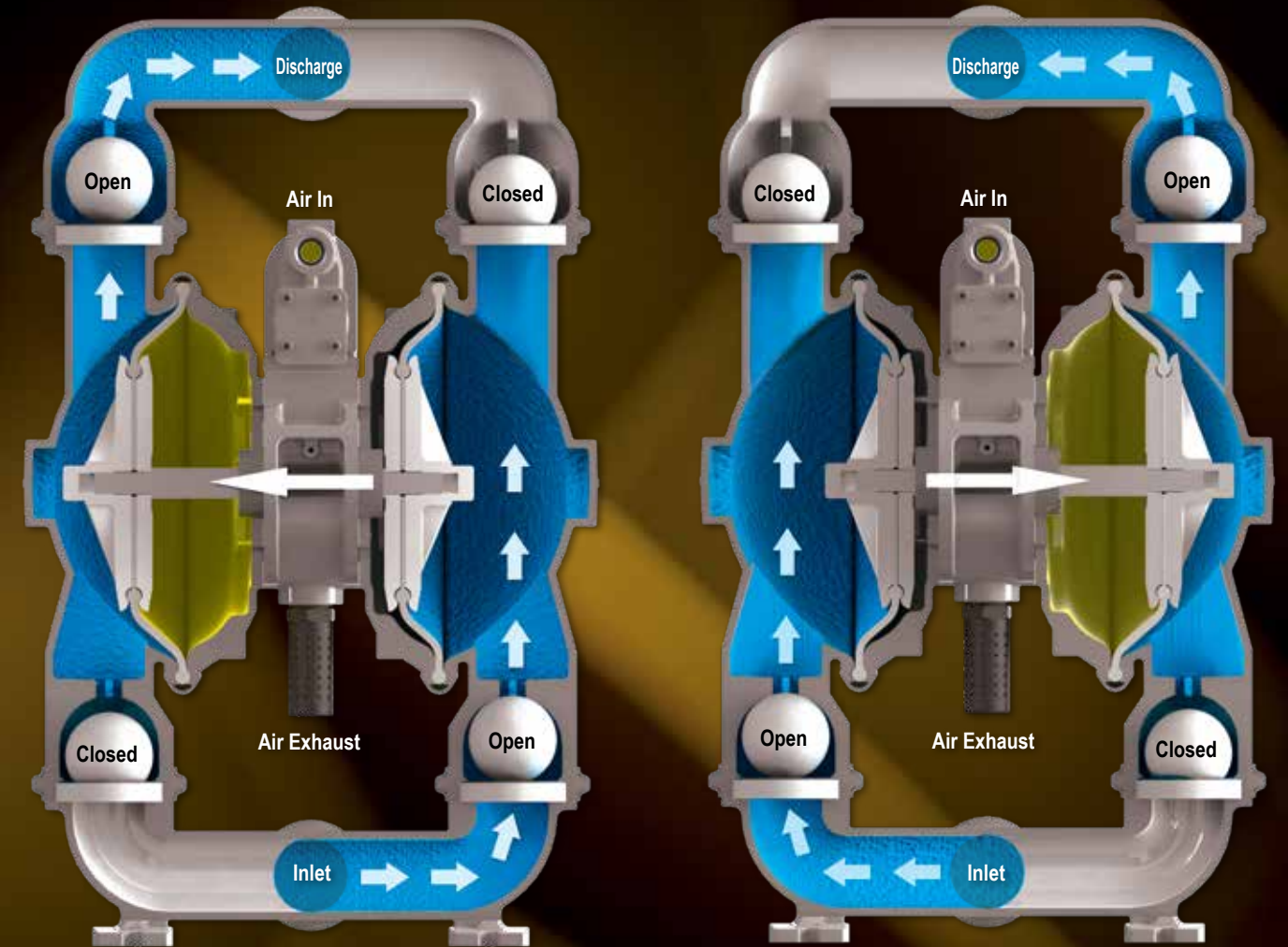

1: Suction Cycle

Compressed air fills left inner chamber, causing the opposing diaphragm to create suction, lifting the lower valve ball, pulling in fluid at inlet. Simultaneously the left chamber is in "Discharge" cycle.

2: Discharge Cycle

Compressed air fills right inner chamber, causing upper valve ball to open and discharge fluid. Simultaneously, the left chamber is in "Suction" cycle.

AIR DISTRIBUTION SYSTEM

Engineered for superior reliability and performance. The patented Elima-Matic air distribution system has been tested the world over to meet or exceed your most demanding applications.

- Metallic and non-metallic options
- Superior flow rates and efficiency
- Superior in-service life
 - Runs well with unclean air
 - Economical rebuild options
 - ATEX compliant options
 - Lube free operation
 - Reliable and durable
 - On/Off reliability
 - Non-freezing

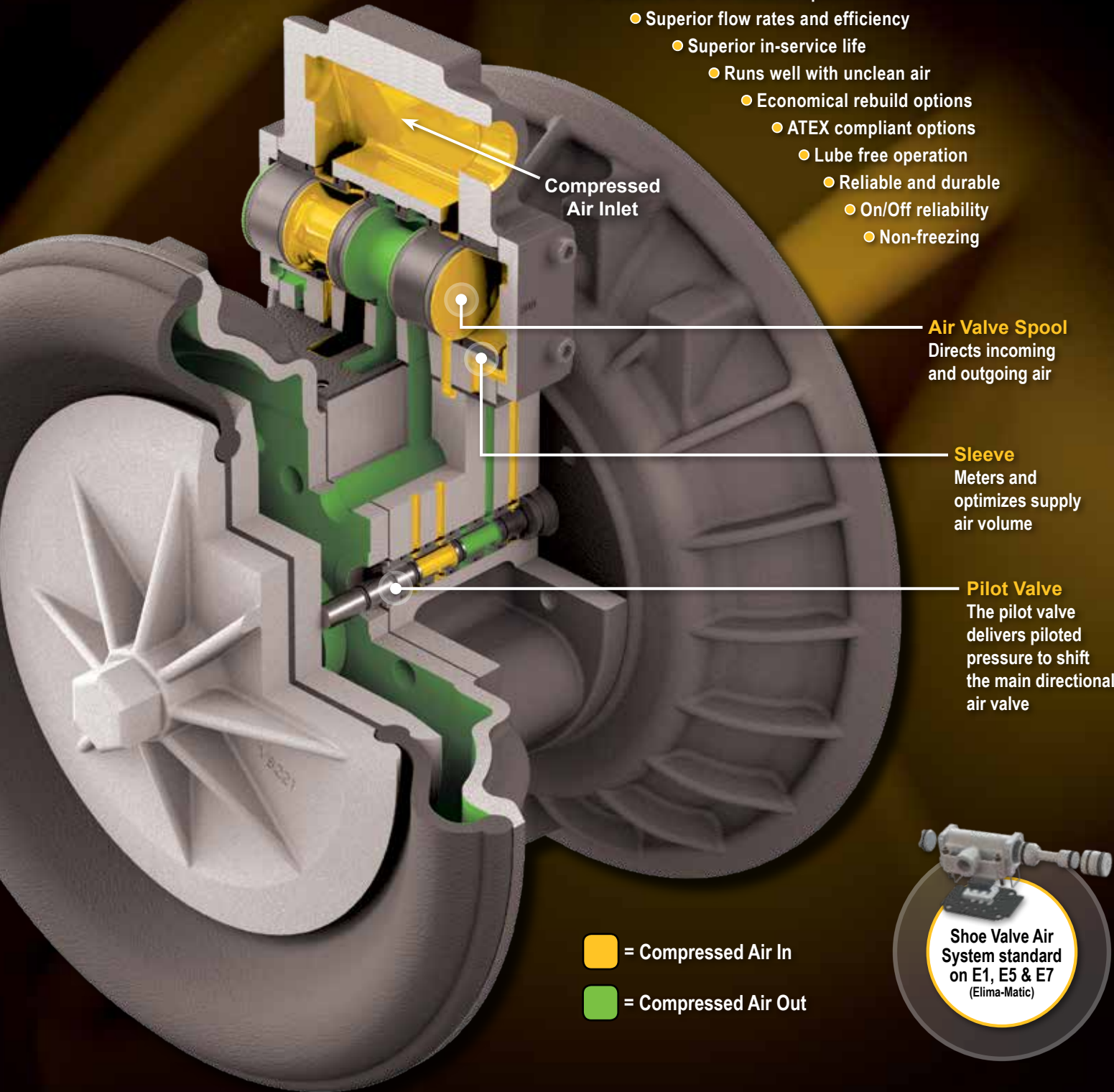

WHY CHOOSE AODD PUMPS

AODD pumps deliver unique benefits that are unrivaled by other pump technologies, making them the clear choice for many of the worlds most challenging applications.



- 1 **Run-dry** without damaging the pump or system
- 2 **Pump solid** laden fluids without pump or product damage
- 3 **Self-priming**, works in suction lift applications
- 4 **Deadheads safely**, with no pump or product damage
- 5 **Shear sensitive**, does not shear or separate product being pumped
- 6 **No electricity required**, and can be fully grounded
- 7 **Low initial purchase price** compared to other technologies
- 8 **Submersible**, can be submerged completely without safety or performance issues
- 9 **Sealless design**, no expensive mechanical seals or packing are required
- 10 **Variable flow and head pressures**, without sophisticated controls

Pump Type:							
	AODD	Centrifugal	Lobe	Gear	Progressive (screw)	Peristaltic (hose)	Piston/Plunger
Technology:	Non PD Reciprocating	Kinetic	PD Rotary	PD Rotary	PD Rotary	PD Rotary	PD Reciprocating
Variable Flow & Head Control: (inherently adjustable)	✓	!	!	!	!	!	!
Deadheads Safely: (at zero energy consumption)	✓	!	!	!	!	!	!
Dry-Running:	✓	✗	✗	✗	✗	✗	✗
Dry-Priming: (lift installations)	✓	✗	✗	✗	✗	✗	!
No Installation Alignment Required:	✓	✗	✗	✗	✗	✗	✗
No Electrical Installation Required:	✓	✗	✗	✗	✗	✗	✗
Portability:	✓	!	!	!	!	!	!
Submersible:	✓	!	✗	✗	✗	✗	✗
Sealless: (no packing or mechanical seals)	✓	!	!	!	!	!	!
No Slip: (thin liquids)	✓	!	!	!	!	!	!
Cavitation Tolerance: (low NPSHa)	✓	✗	!	!	!	!	!
Low Shear & Degradation:	✓	✗	!	!	!	!	!

✓ = Best Fit ! = Limitations ✗ = Not Recommended

FEATURES & BENEFITS

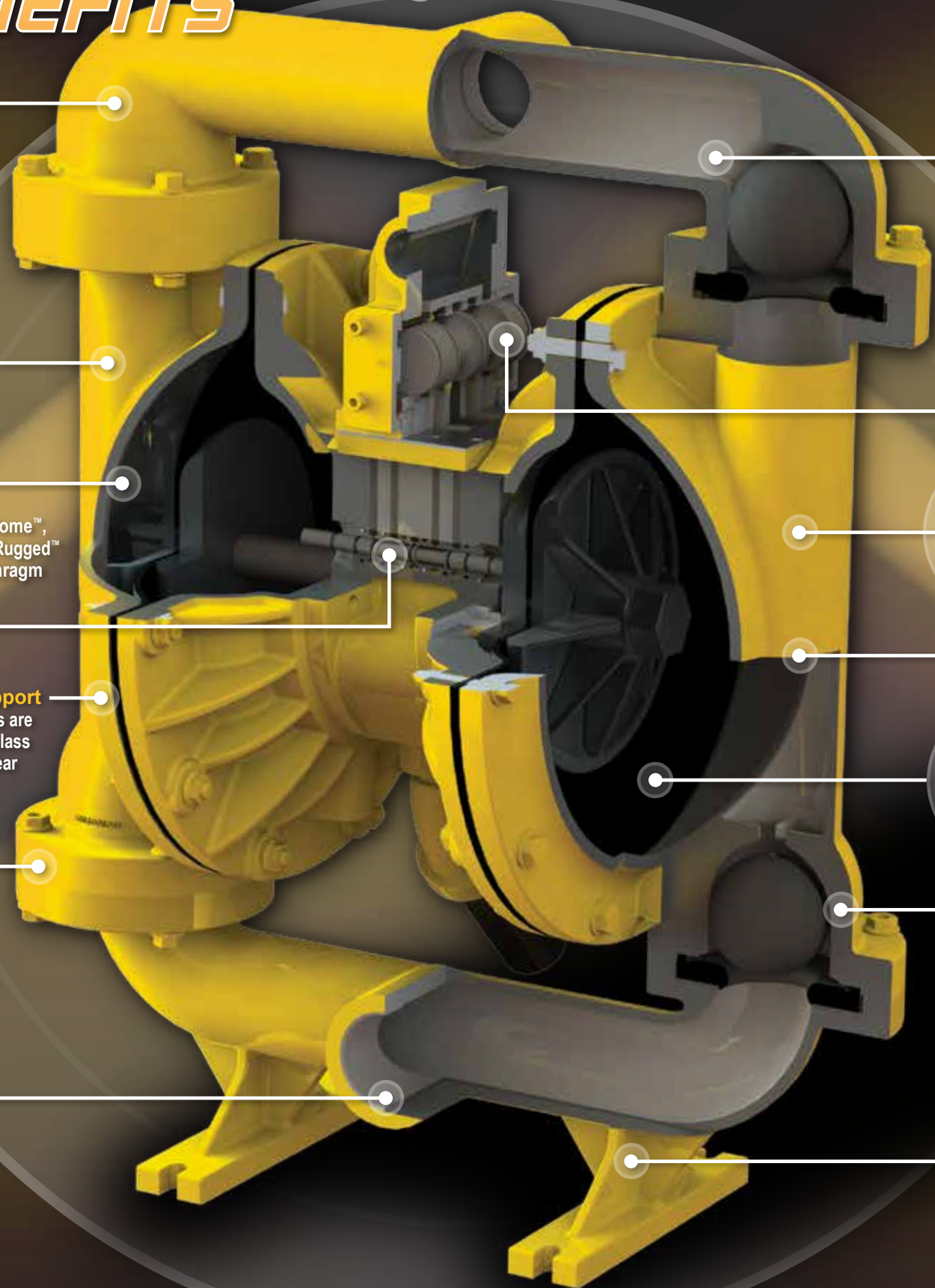

Dimensional Interchangeability
Pumps, air sections and value added diaphragm kits for competitor pumps that are interchangeable.

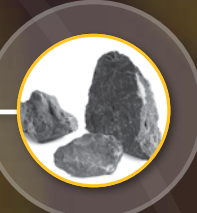

Solids Handling
Versa-Matic pumps can easily and efficiently handle anything from water to 90% solids.



Easy Maintenance
Serviceable designs equal low cost and simple maintenance. Genuine parts kits ensure you have everything in one kit.



Exclusive Elima-Matic Air Valve System
Enhanced air valve system delivers consistent reliability, while maintaining superior air efficiency and lube free operation.



Extended-life Diaphragms
Experience the value of Versa-Dome™, FUSION™, Versa-Rugged™ and 2-Piece diaphragm technologies.



Adjustable Flow & Pressure
Ability to vary flow and discharge pressure up to 125 psi with a simple adjustment of the air supply.



Long-Term Reliability
Advanced features such as: Removable air valve sleeve, modular pilot spool and replaceable seals help ensure reliable functionality.



Chemical Resistance
Wet and Air section materials for an expansive range of chemicals and harsh environments.



Warranty & Support
Versa-Matic pumps are backed by world class support and a 5 year limited warranty.



Low Shearing
Pass shear sensitive solids effectively. Will not froth or separate medium.



Clamped or Bolted Construction
Enhanced sealing capabilities, reliability, and ease of assembly and disassembly.



Run-dry Capable
Able to run-dry for an extended time without damage to pump or components.



Excellent Flow Rates
Advanced flow through casting designs and efficient air distribution create volumetric efficiencies, delivering excellent flow rates and displacement per cycle.



On-demand
On / Off reliability. Operates in "on demand systems" without expensive pressure relief and bypass accessories.

INTERCHANGEABILITY WITH WILDEN® PUMPS

Many Versa-Matic pumps and parts are dimensionally interchangeable with Wilden®. Advance to Versa-Matic to save money and maintain reliability without the expense of changing your system.

● Air Section: Elima-Matic upgrade conversion kits with or without diaphragms

● Diaphragms: Versa-Dome™, Versa-Rugged™ and 2-Piece diaphragm conversion kits

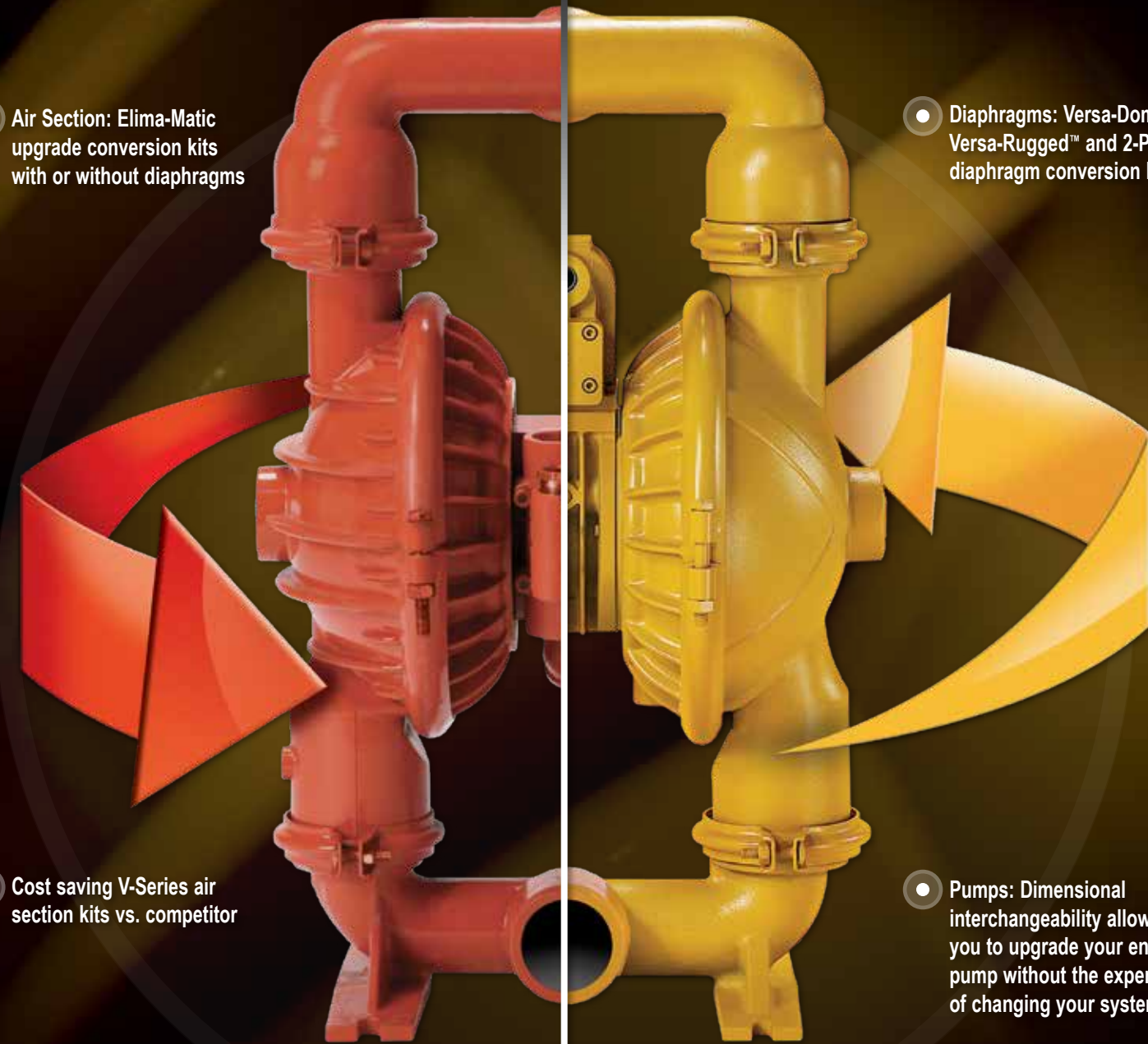

● Cost saving V-Series air section kits vs. competitor

● Pumps: Dimensional interchangeability allows you to upgrade your entire pump without the expense of changing your system



Interchange Options:

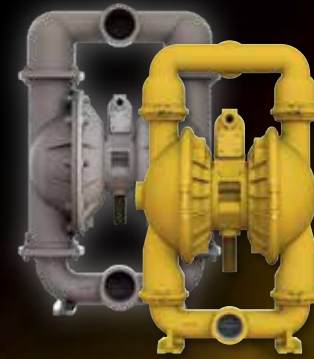

● Complete pumps & parts



● Diaphragm upgrade kits

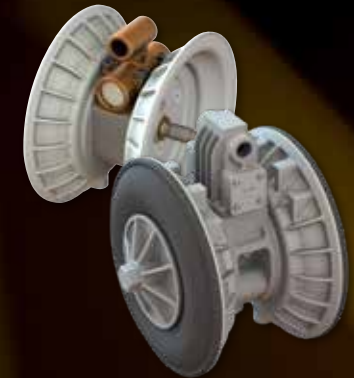

● Complete air section kits

Interchangeability Guide:



= Interchangeable (Dimensionally interchangeable from Wilden® to Versa-Matic)

Interchangeable with Versa-Matic:	Pump Dimensional Interchangeability			Parts, Kits & Accessories Interchangeability			
	Elima-Matic Clamped Metallic	Elima-Matic Bolted Metallic	V-Series Clamped Metallic	Versa-Dome Diaphragm Upgrade Kits	Versa-Rugged & 2-Piece Diaphragm Kits	Elima-Matic Air Section Kits	V-Series Air Section Kits
Wilden® 1 1/4" Clamped Metallic							
Wilden® 2" Clamped Metallic							
Wilden® 3" Clamped Metallic							
Wilden® 1 1/2" Bolted Metallic							
Wilden® 1 1/2" Clamped Non-Metallic							
Wilden® 2" Clamped Non-Metallic							
Wilden® 2" PS820 Advanced Fit Metallic							
Wilden® 3" PS1520 Advanced Fit Metallic							

* Interchangeable footprint only, with similar dimensions to Wilden® 1 1/2" non-metallic clamped unit.

** Interchangeable porting only, with similar footprint dimensions to Wilden® center ported 2" non-metallic clamped unit.

This chart is a general interchange guide, please consult factory or your distributor for specific details. Wilden® is a registered trademark of Wilden Pump and Engineering Company, a Dover Resources Company. Versa-Matic and its products are not affiliated with Wilden Pump and Engineering Company. All original equipment manufacturers' names, colors, pictures, descriptions and part numbers are used for identification purposes only.

PUMP MODEL CODES

1 2 3 4 5 6 7 8 9 10 - A A A

- 1 Model**
- E Elima-Matic®
 - U Ultra-Matic®
 - V V-Series® (classic)

- 2 Pump Size**
- 6 1/4"
 - 8 3/8"
 - 5 1/2"
 - 7 3/4"
 - 1 1"
 - 4 1 1/4" or 1 1/2"
 - 40 1 1/2"
 - 2 2"
 - 3 3"

- 3 Wetted (Non-elastomeric)**
- A Aluminum
 - C Cast Iron
 - S Stainless Steel
 - P Polypropylene
 - K PVDF
 - B Aluminum (Screen Mounted)

- 4 Non-Wetted**
- A Aluminum
 - S Stainless Steel
 - P Polypropylene
 - Z PTFE-Coated Aluminum
 - J Nickel-Plated Aluminum
 - C Cast Iron
 - Q Epoxy-Coated Aluminum

- 5 Diaphragm**
- 1 Neoprene
 - 2 Nitrile
 - 3 FKM (Fluoroelastomers)
 - 4 Nordel® (EPDM)
 - 5 PTFE
 - 6 TPE-XL (Santoprene®)
 - 7 Hytrel®
 - Y FDA TPE-XL (Santoprene®)

- 6 Diaphragm Series**
- R Versa-Rugged™
 - D Versa-Dome™
 - X Thermo-Matic™
 - T 2-piece
 - B Versa-Tuff™ (1-piece)
 - F FUSION™ (1-piece, int. plate)

- 7 Valve Ball**
- 1 Neoprene
 - 2 Nitrile
 - 3 FKM (Fluoroelastomers)
 - 4 Nordel® (EPDM)
 - 5 PTFE
 - 6 TPE-XL (Santoprene®)
 - 7 Hytrel®
 - S Stainless Steel
 - Y FDA TPE-XL (Santoprene®)

- 8 Valve Seat/O-Ring**
- 1 Neoprene
 - 2 Nitrile
 - 3 FKM (Fluoroelastomers)
 - 4 Nordel® (EPDM)
 - 5 PTFE
 - 6 TPE-XL (Santoprene®)
 - 7 Hytrel®
 - A Aluminum / PTFE
 - S Stainless Steel / PTFE
 - C Carbon Steel / PTFE
 - T PTFE Encapsulated Silicone
 - Y FDA TPE-XL (Santoprene®)

- 9 Construction**
- 9 Bolted
 - 0 Clamped

- 10 Revision Level**

- A A A Options**

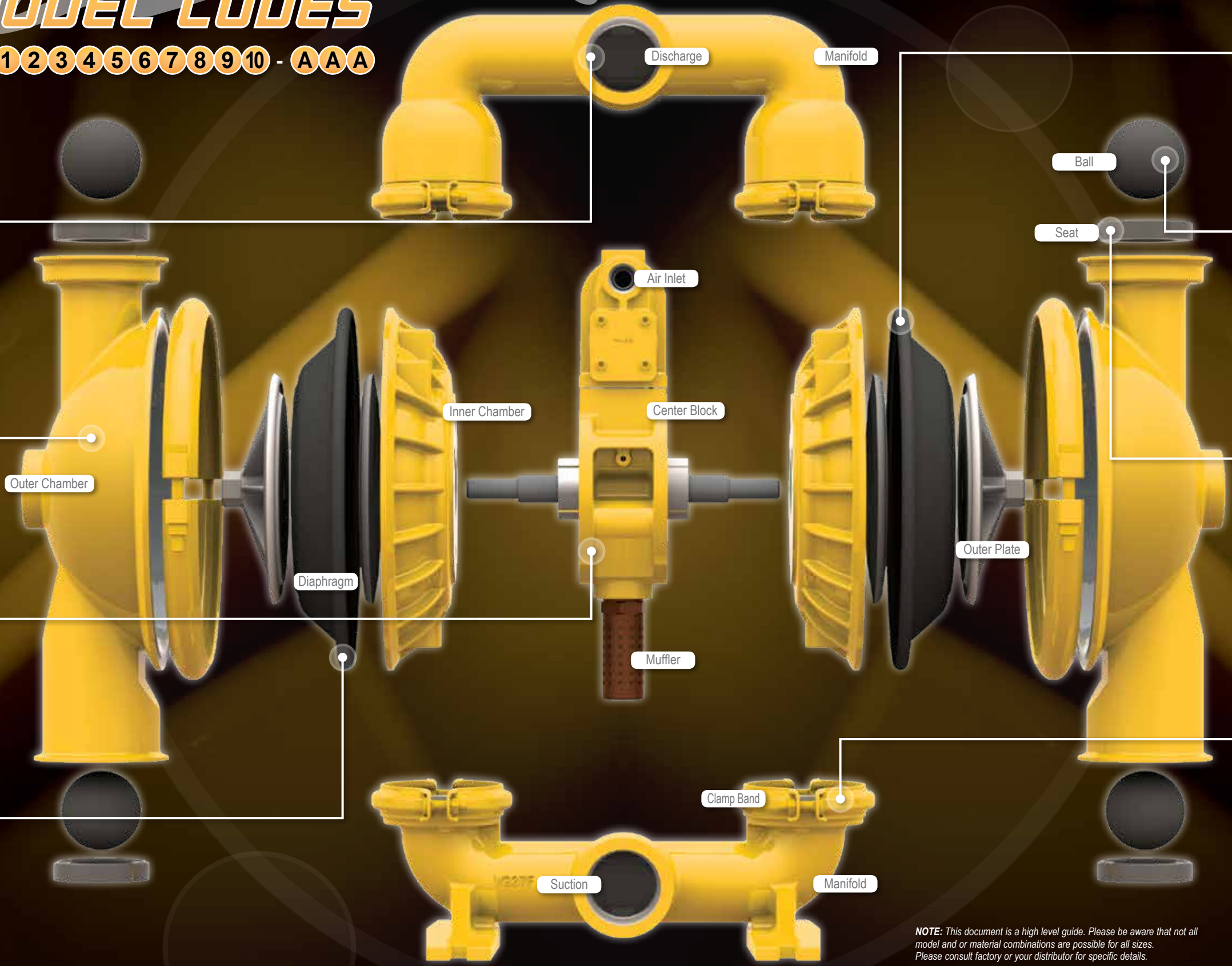

NOTE: This document is a high level guide. Please be aware that not all model and or material combinations are possible for all sizes. Please consult factory or your distributor for specific details.

METALLIC BOLTED

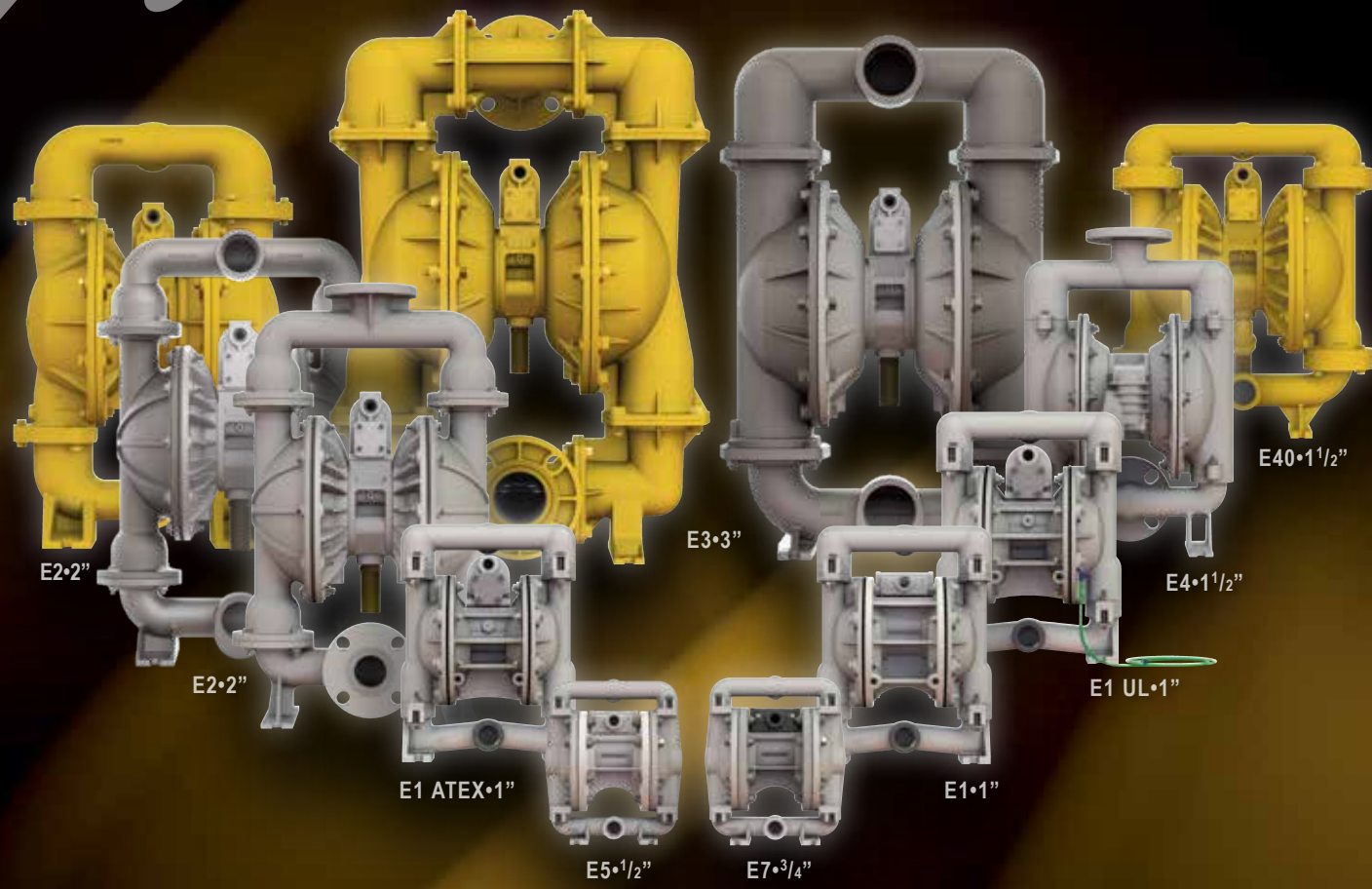

**Superior positive seal for safe, reliable transfer.
Specially suited for thin liquids handling.**

Features & Benefits:

- Durable and long lasting construction
- Wide range of sizes and applications
- Diverse material offering for your applications
- Submersible and portable
- Non-freezing, non-stalling
- On / Off reliability

Specifications:

- **Sizes:** 1/2" through 3"
- **Wetted Materials:** Aluminum, Cast Iron, Stainless Steel
- **Max Flow Rate:** 273 gpm (1033 lpm)
- **Max Suction Lift:** 32' (9.8m) wet
19' (5.8m) dry
- **Max Disp. per Stroke:** 1.45 gallons (5.5 liters)

1/2" (12.7mm) E5 Metallic Bolted

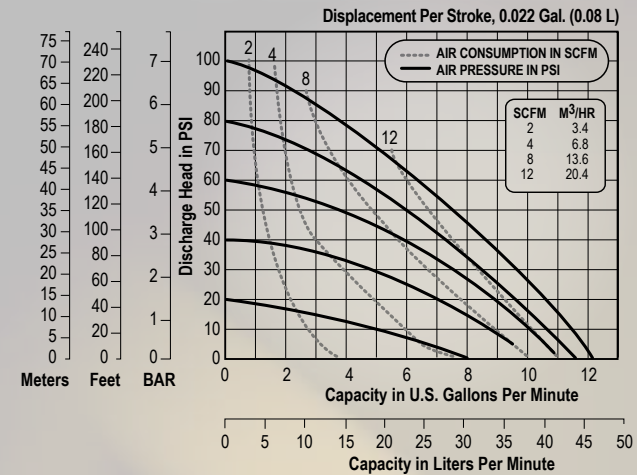

Max Flow:

- 12 gpm (45.4 lpm)

Porting:

- Center Horizontal

Center Section:

- Aluminum (coating options)
- Polypropylene

Wetted Section:

- Aluminum
- Stainless Steel

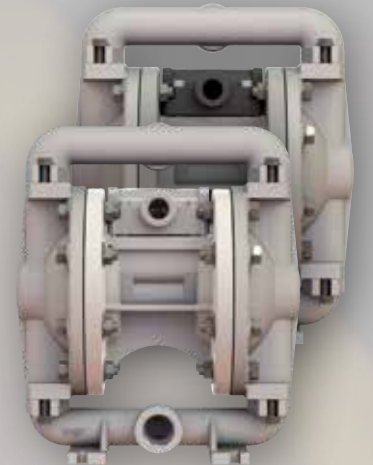

3/4" (19mm) E7 Metallic Bolted

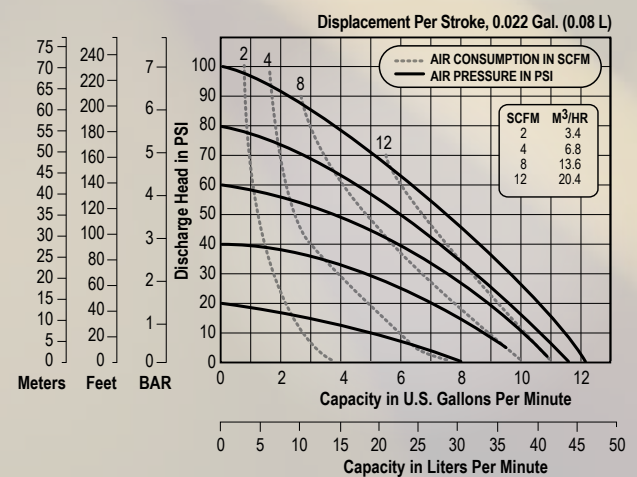

Max Flow:

- 12 gpm (45.4 lpm)

Porting:

- Center Horizontal

Center Section:

- Aluminum (coating options)
- Polypropylene

Wetted Section:

- Aluminum

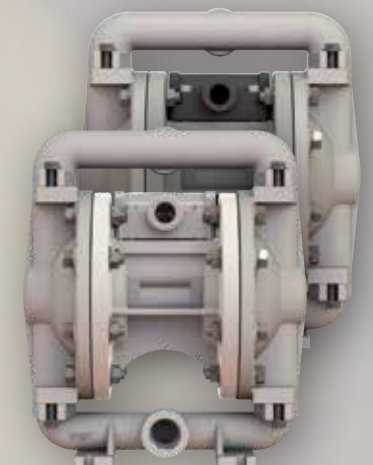

1" (25.4mm) E1 Metallic Bolted

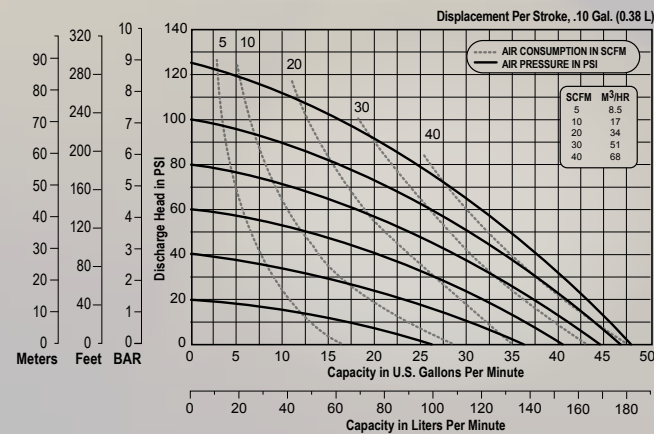

Max Flow:

- 46 gpm (174.1 lpm)

Porting:

- Center Horizontal

Center Section:

- Polypropylene

Wetted Section:

- Aluminum
- Stainless Steel

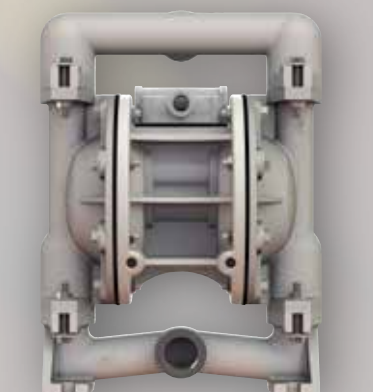

Note: All performance curves based on the following: Elastomeric fitted pump, flooded suction, water at ambient conditions. The use of other materials and varying hydraulic conditions may result in deviations in excess of 5%.

1" (25.4mm) E1 Metallic Bolted

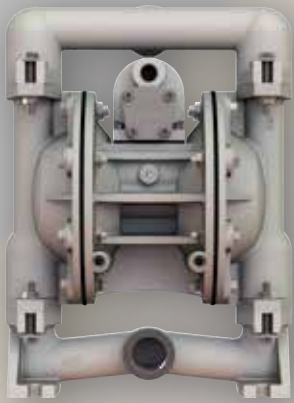

Max Flow:
• 49 gpm (185.5 lpm)

Porting:
• Center Horizontal

Center Section:
• Aluminum (coating options)

Wetted Section:
• Aluminum
• Stainless Steel

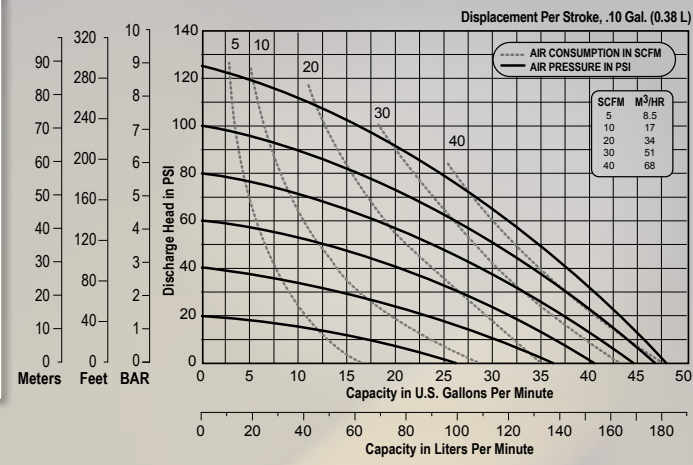

1 1/2" (38mm) E40 Metallic Bolted

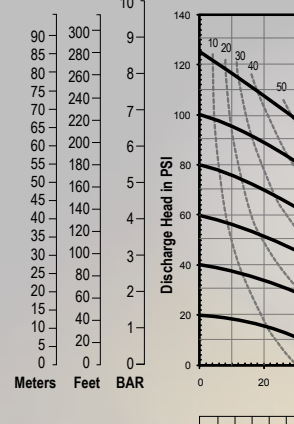

Max Flow:
• 123 gpm (465 lpm)

Porting:
• Center Horizontal

Center Section:
• Aluminum (coating options)
• Stainless Steel

Wetted Section:
• Aluminum
• Cast Iron
• Stainless Steel

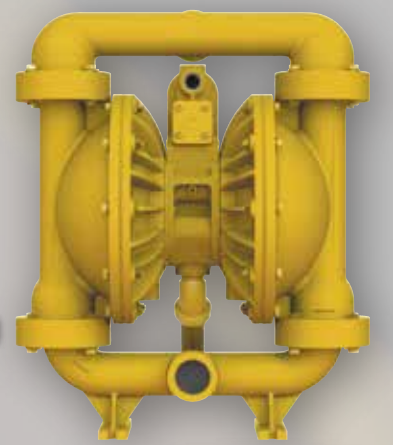
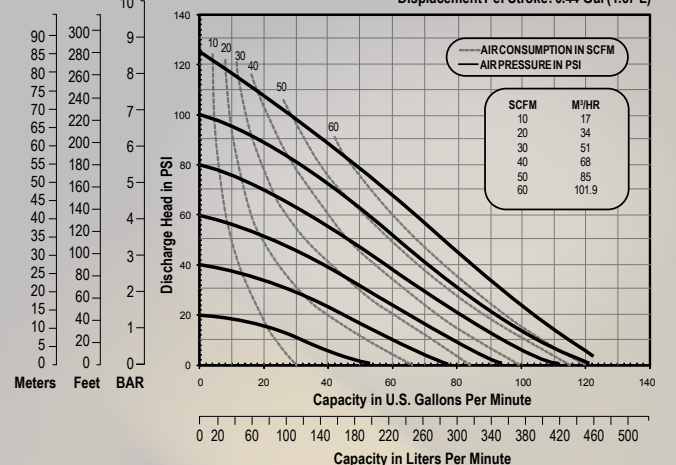
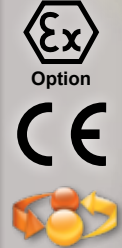

1" (25.4mm) E1 Metallic Bolted • UL

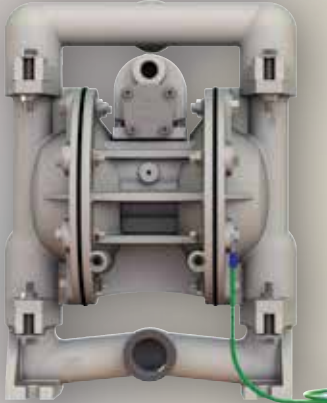

Max Flow:
• 35 gpm (132 lpm)

Porting:
• Center Horizontal

Center Section:
• Aluminum (coating options)

Wetted Section:
• Aluminum
• Stainless Steel

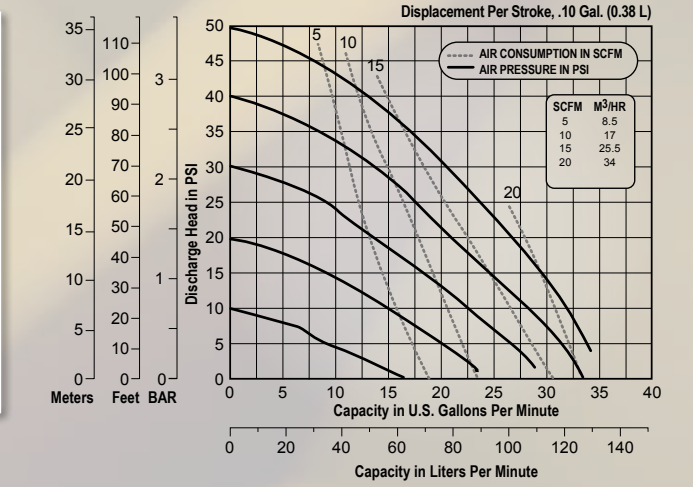

2" (50.8mm) E2 Metallic Bolted

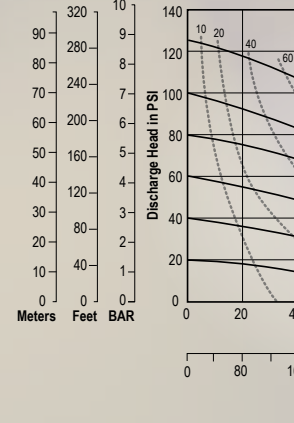

Max Flow:
• 160 gpm (606 lpm)

Porting:
• Center Horizontal
• Center Vertical

Center Section:
• Aluminum (coating options)
• Stainless Steel

Wetted Section:
• Cast Iron
• Stainless Steel

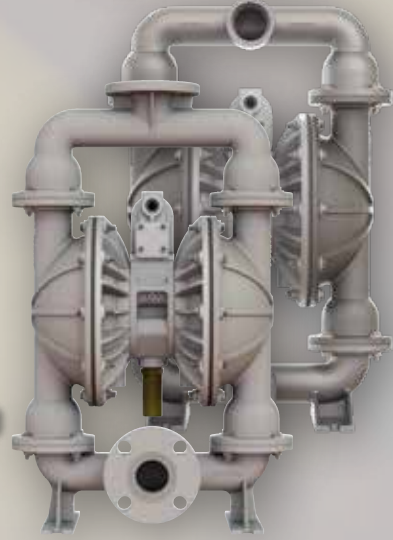
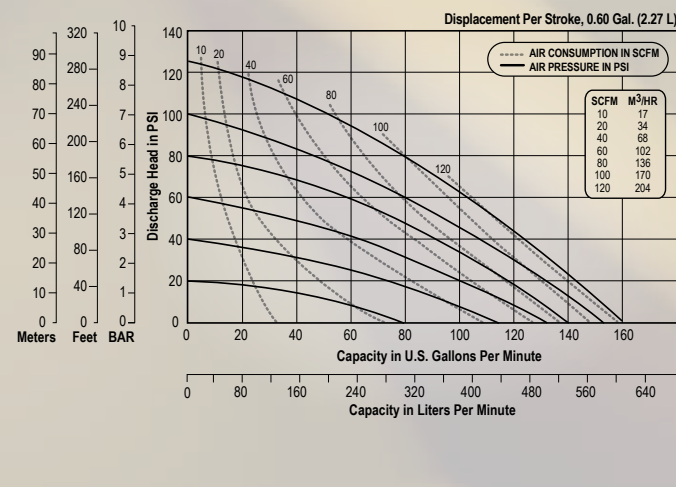
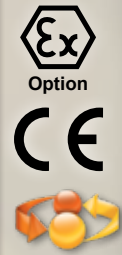

1 1/2" (38mm) E4 Metallic Bolted

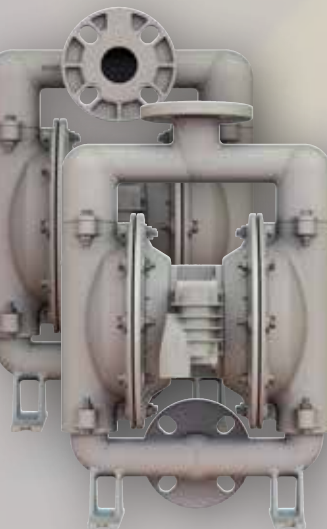

Max Flow:
• 72 gpm (272.5 lpm)

Porting:
• Center Horizontal
• Center Vertical

Center Section:
• Aluminum (coating options)

Wetted Section:
• Stainless Steel

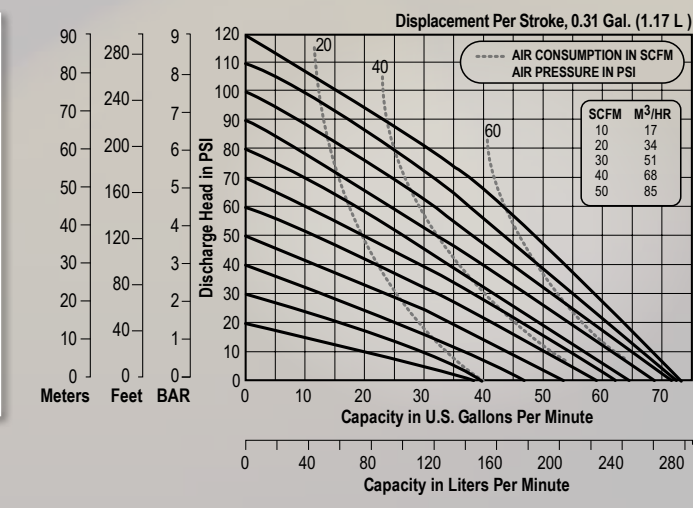

2" (50.8mm) E2 Metallic Bolted • Aluminum

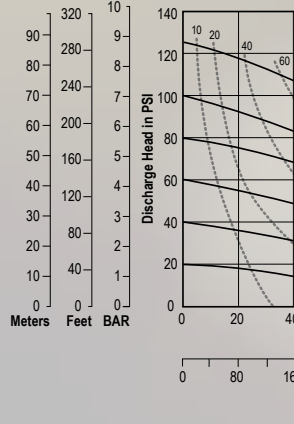

Max Flow:
• 163 gpm (617 lpm)

Porting:
• Center Horizontal

Center Section:
• Aluminum (coating options)

Wetted Section:
• Aluminum

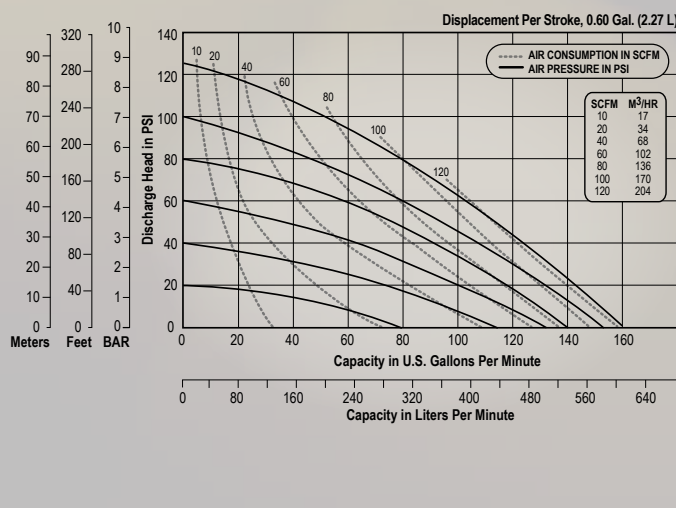
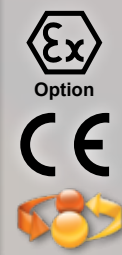

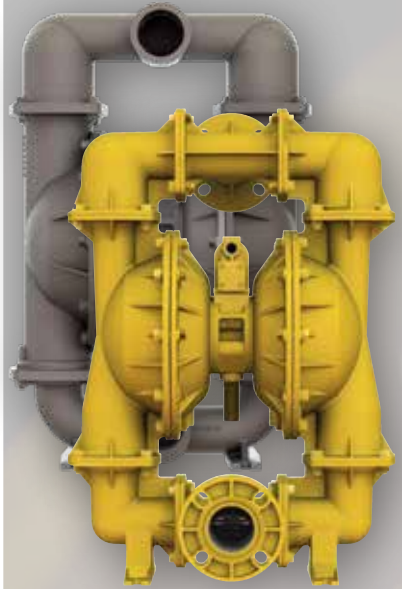

- Max Flow:**
• 273 gpm (1033 lpm)
- Porting:**
• Center Horizontal
• Center Vertical
- Center Section:**
• Aluminum (coating options)
• Stainless Steel
- Wetted Sections:**
• Aluminum
• Stainless Steel

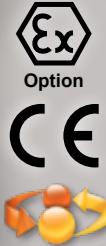

3" (76.2mm) E3 Metallic Bolted

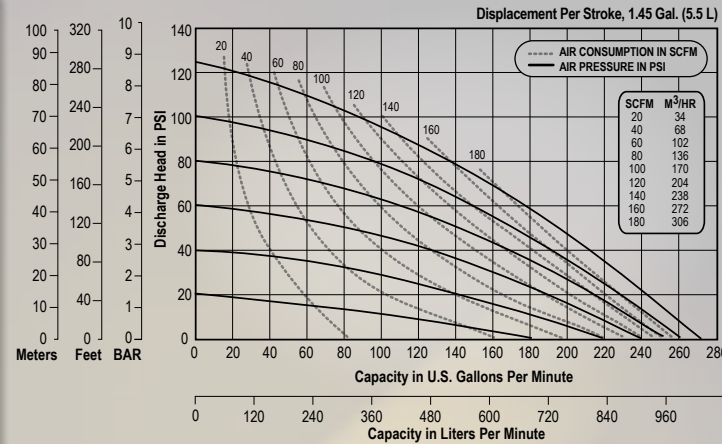

Learn more about Elima-Matic pumps by scanning this QR code with your smartphone.
Need the App? Download any FREE QR App from your devices store.

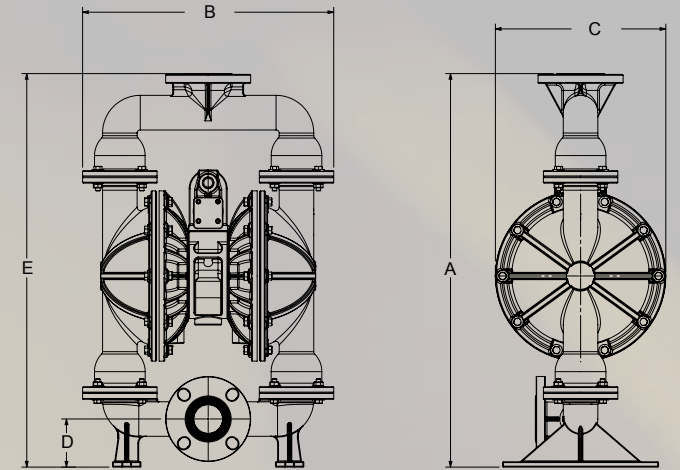

Multiple Pump Constructions



Bolted

- Robust positive seal for leak free operation
- Thick, durable castings
- Easy positioning and alignment of parts during reassembly



Clamped

- Quick and easy assembly/disassembly
- Suited for rapid cleaning operations
- Interchangeable with competitor products



Transformable

- Easily convert Versa-Matic or competitor clamp style pumps to bolted models
- Dimensional interchangeable Drop-in design for easy and rapid installation.

SPECIFICATIONS										DIMENSIONS: Tolerance: ±1/8" (±3mm)				
Pump Model	Port Size	Flow Rate	Solids Handling -Up to-	Head -Up to-	Displacement -Per Stroke-	Suction Lift		Air		A Height	B Width	C Depth	D Base to Center Suction	E Base to Center Discharge
						Dry	Wet	In	Out					
E5	1/2" (internal)	0-12 gpm (0-45.4 lpm)	0.0625" (1.6 mm)	125 psi (8.6 bar)	0.022 gallon (0.08 liter)	13' (3.9 m)	22' (6.7 m)	0.375" NPT	0.375" NPT	10.05" (255.3 mm)	8.39" (213.1 mm)	6.25" (158.8 mm)	0.95" (24.1 mm)	9.35" (237.5 mm)
E5 ATEX	1/2" (internal)	0-12 gpm (0-45.4 lpm)	0.0625" (1.6 mm)	125 psi (8.6 bar)	0.022 gallon (0.08 liter)	13' (3.9 m)	22' (6.7 m)	0.375" NPT	0.375" NPT	10.05" (255.3 mm)	8.39" (213.1 mm)	6.25" (158.8 mm)	0.95" (24.1 mm)	9.35" (237.5 mm)
E7	3/4" (internal)	0-12 gpm (0-45.4 lpm)	0.0625" (1.6 mm)	125 psi (8.6 bar)	0.022 gallon (0.08 liter)	13' (3.9 m)	22' (6.7 m)	0.375" NPT	0.375" NPT	10.05" (255.3 mm)	8.39" (213.1 mm)	8.51" (216.2 mm)	0.95" (24.1 mm)	9.35" (237.5 mm)
E1	1" (internal)	0-46 gpm (0-174.1 lpm)	0.125" (3.2 mm)	125 psi (8.6 bar)	0.09 gallon (0.34 liter)	15' (4.6 m)	31' (9.4 m)	0.375" NPT	0.5" NPT	14.54" (369.3 mm)	10.72" (272.3 mm)	9.33" (237 mm)	1.56" (38.6 mm)	13.73" (348.7 mm)
E1 ATEX	1" (internal)	0-49 gpm (0-185.5 lpm)	0.125" (3.2 mm)	125 psi (8.6 bar)	0.10 gallon (0.38 liter)	16' (4.9 m)	31' (9.4 m)	0.375" NPT	0.5" NPT	14.54" (369.3 mm)	10.72" (272.3 mm)	9.33" (237 mm)	1.56" (38.6 mm)	13.73" (348.7 mm)
E1 UL	1" (internal)	0-35 gpm (0-132 lpm)	0.125" (3.2 mm)	125 psi (8.6 bar)	0.10 gallon (0.38 liter)	15' (4.6 m)	25' (7.6 m)	0.375" NPT	0.5" NPT	14.54" (369.3 mm)	10.72" (272.3 mm)	9.33" (237 mm)	1.56" (38.6 mm)	13.73" (348.7 mm)
E4 ATEX	1 1/2" (internal)	0-72 gpm (0-272.5 lpm)	0.188" (4.78 mm)	125 psi (8.6 bar)	0.31 gallon (1.17 liter)	15' (4.6 m)	25' (7.6 m)	0.5" NPT	0.75" NPT	20.16" (512.1 mm)	13.2" (335.3 mm)	7" (177.8 mm)	3.13" (79.5 mm)	17.41" (442.2 mm)
E40 ATEX	1 1/2" (internal)	0-123 gpm (0-465 lpm)	0.25" (6 mm)	125 psi (8.6 bar)	0.44 gallon (1.67 liter)	19' (5.8 m)	31' (9.4 m)	0.5" NPT	1" NPT	22.2" (563.9 mm)	18.55" (471.2 mm)	12.22" (310.4 mm)	3.13" (79.5 mm)	20.9" (530.9 mm)
E2 Alum ATEX	2" (internal)	0-163 gpm (0-617 lpm)	0.4375" (11.1 mm)	125 psi (8.6 bar)	0.60 gallon (2.27 liter)	18' (5.5 m)	32' (9.8 m)	0.5" NPT	1" NPT	26.45" (671.8 mm)	17.72" (450.1 mm)	13.13" (333.5 mm)	2.52" (64 mm)	24.88" (632 mm)
E2 ATEX	2" (internal)	0-160 gpm (0-606 lpm)	0.25" (6 mm)	125 psi (8.6 bar)	0.49 gallon (1.85 liter)	14' (4.3 m)	30' (9.1 m)	0.5" NPT	1" NPT	27.77" (705.4 mm)	17.72" (450.1 mm)	12.03" (305.6 mm)	3.39" (86.1 mm)	27.77" (705.4 mm)
E3 ATEX Aluminum	3" (internal)	0-273 gpm (0-1033 lpm)	0.375" (9.5 mm)	125 psi (8.6 bar)	1.45 gallon (5.5 liter)	16' (4.9 m)	31' (9.4 m)	0.5" NPT	1" NPT	36.31" (922.2 mm)	25.12" (638.1 mm)	16.11" (409.2 mm)	4.38" (111.3 mm)	32.38" (822.5 mm)
E3 ATEX	3" (internal)	0-273 gpm (0-1033 lpm)	0.375" (9.5 mm)	125 psi (8.6 bar)	1.45 gallon (5.5 liter)	16' (4.9 m)	31' (9.4 m)	0.5" NPT	1" NPT	36.19" (919.2 mm)	22.06" (560.3 mm)	16.14" (410 mm)	4.37" (111 mm)	32.25" (819.15 mm)

Note: See Service Manual for complete specifications or for dimensionally interchangeable drop-in options.

Metallic Clamped

METALLIC CLAMPED

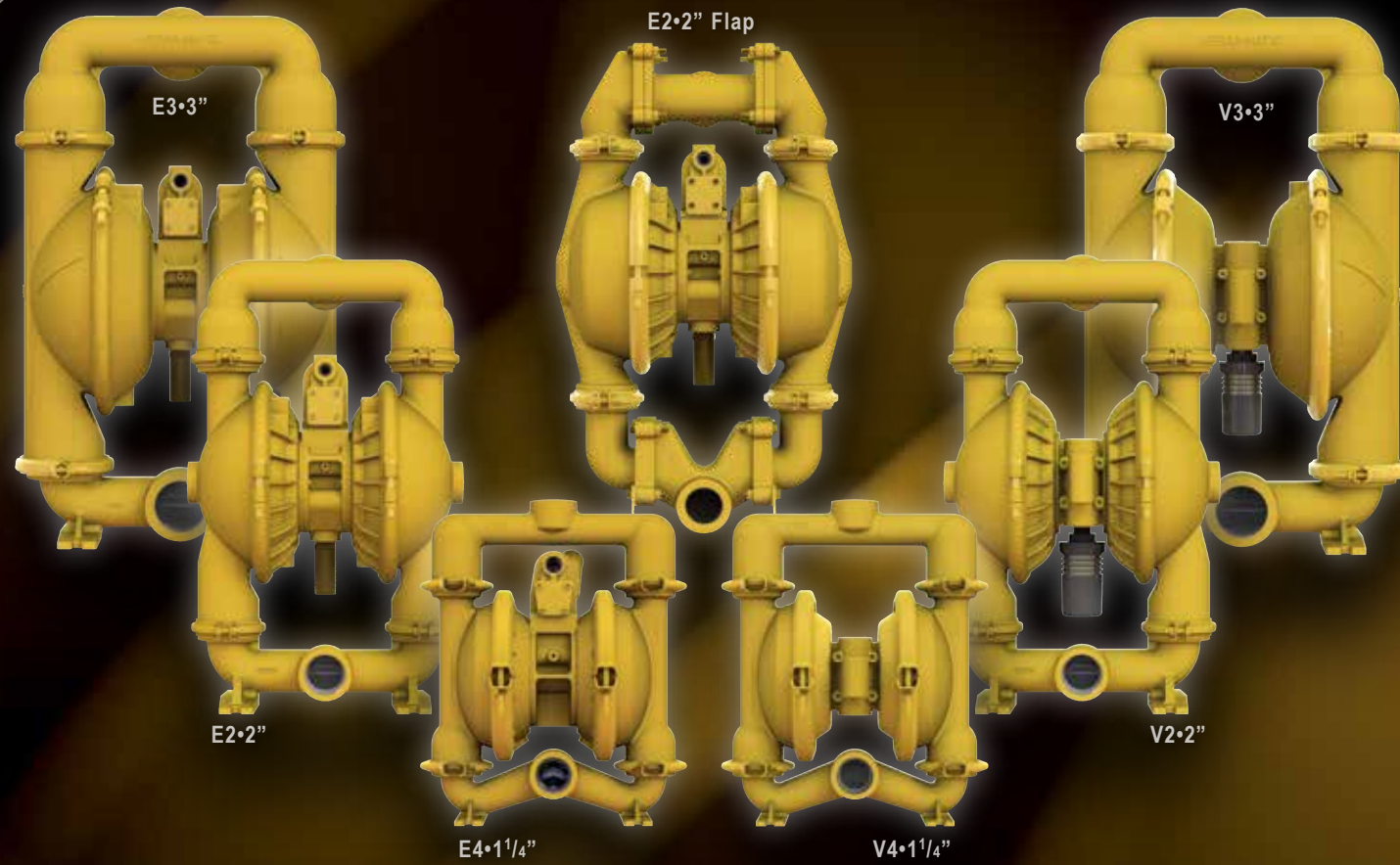

Classic clamped design for proven performance and interchangeability.

Features & Benefits:

- Simple clamped assembly
- Rigid and durable construction
- Wide range of sizes and applications
- Diverse material offering for your applications
- Submersible and portable
- Non-freezing, Non-stalling
- On/Off reliability

Specifications:

- **Sizes:** 1 1/4" through 3"
- **Wetted Materials:** Aluminum, Cast Iron, Stainless Steel
- **Max Flow Rate:** 234 gpm (886 lpm)
- **Max Suction Lift:** 32' (9.8 m) wet
20' (6.1 m) dry
- **Max Disp. per Stroke:** 1.38 gallons (5.22 liters)

1 1/4" (38mm) E4 Metallic Clamped

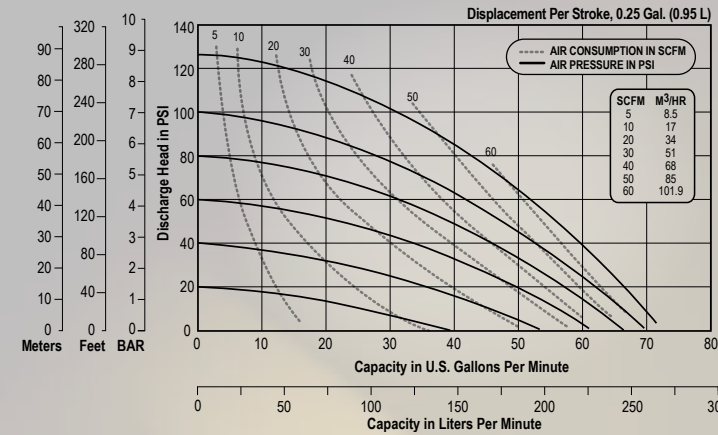

- Max Flow:**
• 71 gpm (268 lpm)
- Porting:**
• Discharge Vertical
• Suction Horizontal
• Screen Mounted
- Center Section:**
• Aluminum (coating options)
- Wetted Section:**
• Aluminum
• Cast Iron
• Stainless Steel

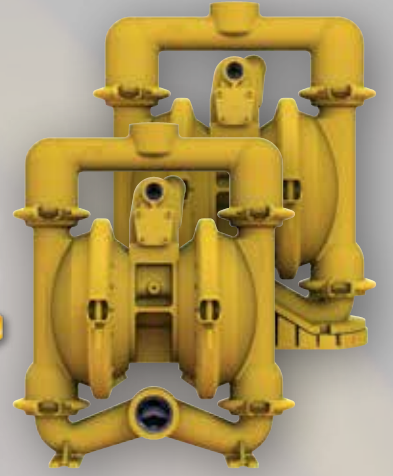
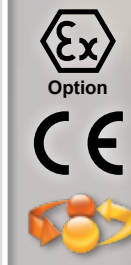

2" (50.8mm) E2 Metallic Clamped

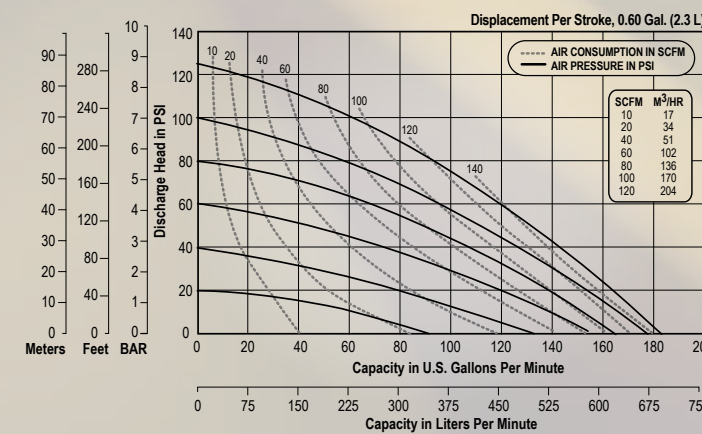

- Max Flow:**
• 185 gpm (700 lpm)
- Porting:**
• Center Horizontal
• Screen Mounted
- Center Section:**
• Aluminum (coating options)
- Wetted Section:**
• Aluminum
• Cast Iron
• Stainless Steel

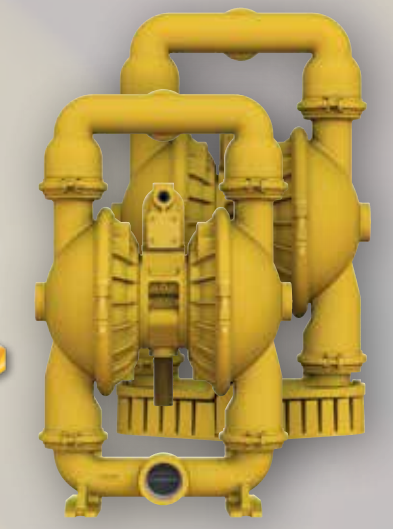
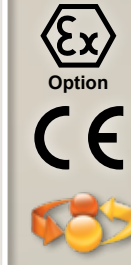

2" (50.8mm) E2 Metallic Clamped • Flap

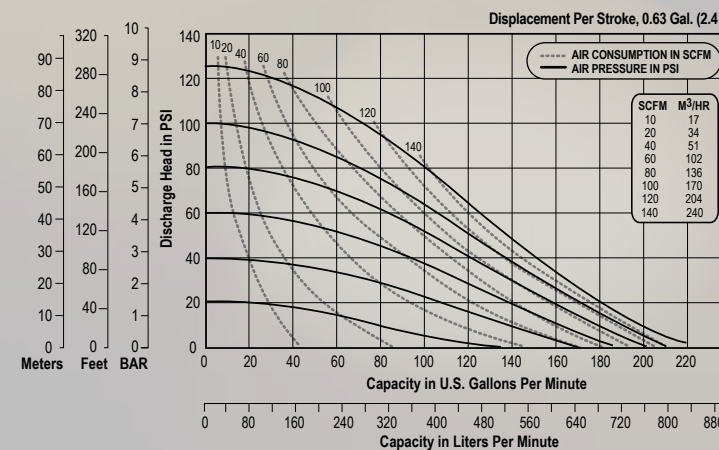

- Max Flow:**
• 219 gpm (829 lpm)
- Porting:**
• Center Horizontal
- Center Section:**
• Aluminum (coating options)
- Wetted Section:**
• Aluminum

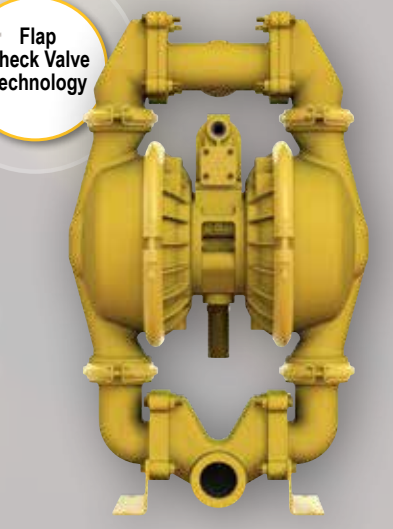

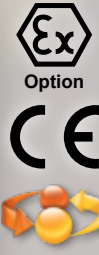
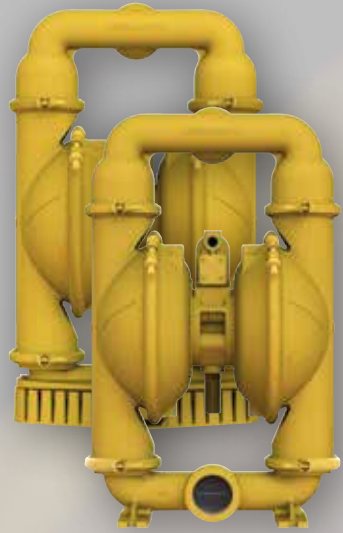

- Max Flow:**
• 234 gpm (886 lpm)
- Porting:**
• Center Horizontal
• Screen Mounted
- Center Section:**
• Aluminum (coating options)
- Wetted Section:**
• Aluminum
• Cast Iron
• Stainless Steel

3" (76.2mm) E3 Metallic Clamped

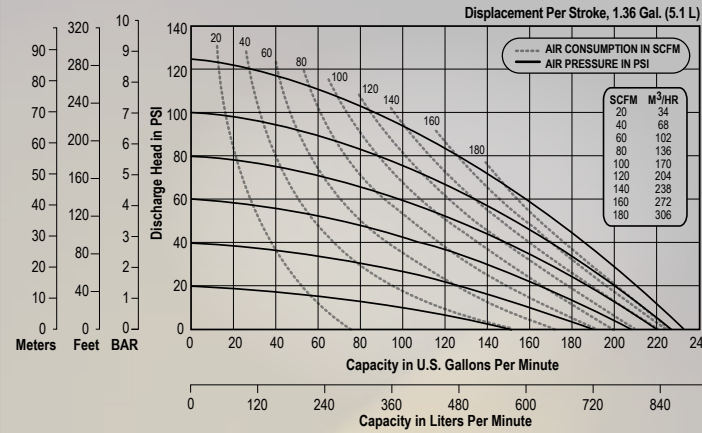

1 1/4" (38mm) V4 Metallic Clamped

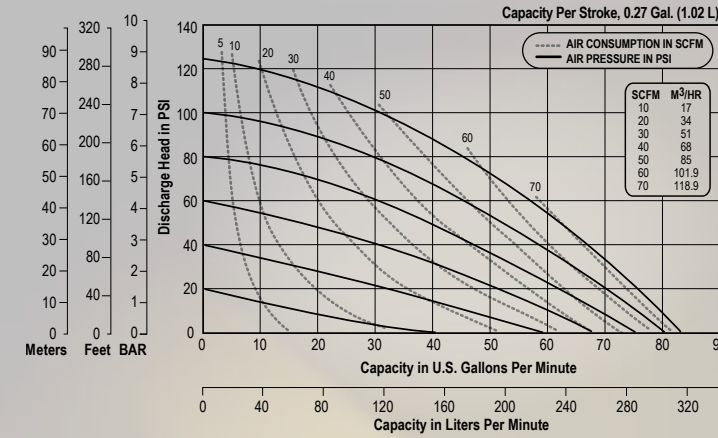

- Max Flow:**
• 84 gpm (317 lpm)
- Porting:**
• Center Horizontal
• Screen Mounted
- Center Section:**
• Metallic (coating options)
- Wetted Section:**
• Aluminum
• Cast Iron
• Stainless Steel

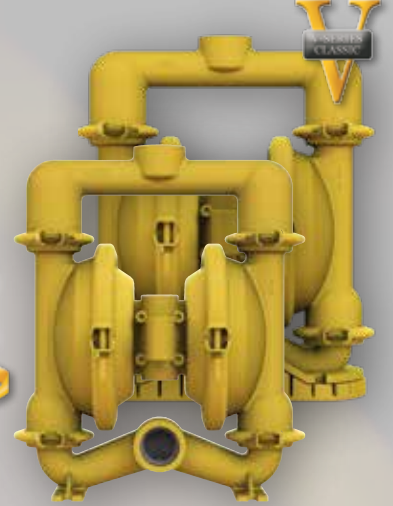
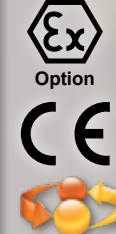

SPECIFICATIONS							DIMENSIONS: Tolerance: ±1/8" (±3mm)							
Pump Model	Port Size	Flow Rate	Solids Handling -Up to-	Head -Up to-	Displacement -Per Stroke-	Suction Lift		Air		A Height	B Width	C Depth	D Base to Center Suction	E Base to Center Discharge
						Dry	Wet	In	Out					
E4	1 1/2" (internal)	0-71 gpm (0-268 lpm)	0.187" (4.76 mm)	110 psi (7.6 bar)	0.31 gallon (1.17 liter)	15' (4.6 m)	25' (7.6 m)	0.5" NPT	0.75" NPT	18" (457.2 mm)	14.25" (361 mm)	11.5" (292.1 mm)	2.37" (60 mm)	16.75" (425.45 mm)
V4	1 1/2" (internal)	0-84 gpm (0-317 lpm)	0.187" (4.76 mm)	110 psi (7.6 bar)	0.31 gallon (1.17 liter)	20' (6.1 m)	25' (7.6 m)	0.375" NPT	0.75" NPT	18" (457.2 mm)	14.5" (368.3 mm)	11.5" (292.1 mm)	2.5" (63.5 mm)	16.75" (425.45 mm)
E2	2" (internal)	0-185 gpm (0-700 lpm)	0.25" (6.4 mm)	125 psi (8.6 bar)	0.52 gallon (2.0 liter)	17' (5.2 m)	32' (9.8 m)	0.5" NPT	1" NPT	26.69" (677.9 mm)	16.38" (416.1 mm)	13.59" (345.2 mm)	2.03" (51.6 mm)	25.05" (636.3 mm)
E2 Tri-Clamp	2" (internal)	0-185 gpm (0-700 lpm)	0.25" (6.4 mm)	125 psi (8.6 bar)	0.52 gallon (2.0 liter)	17' (5.1 m)	32' (9.5 m)	0.5" NPT	1" NPT	26.22" (666 mm)	17.18" (436.4 mm)	13.62" (345.9 mm)	1.72" (43.7 mm)	24.72" (627.9 mm)
E2 Flap Valve	2" (internal)	0-219 gpm (0-829 lpm)	1.125" (28.6 mm)	125 psi (8.6 bar)	0.63 gallon (2.4 liter)	11' (3.4 m)	26' (7.9 m)	0.5" NPT	1" NPT	28.5" (723.8 mm)	17.37" (441.3 mm)	13.59" (345.2 mm)	1.81" (46.1 mm)	25.5" (647.6 mm)
V2	2" (internal)	0-152 gpm (0-575 lpm)	0.25" (6.35 mm)	100 psi (7 bar)	.77 gallon (2.92 liter)	20' (6.1 m)	25' (7.6 m)	0.5" NPT	0.75" NPT	26.5" (673.1 mm)	16.13" (409.6 mm)	10.5" (266.7 mm)	1.75" (38.1 mm)	25" (635.03 mm)
E3	3" (internal)	0-234 gpm (0-886 lpm)	0.375" (9.5 mm)	125 psi (8.6 bar)	1.36 gallon (5.1 liter)	20' (6.1 m)	32' (9.8 m)	0.5" NPT	1" NPT	32.09" (815.1 mm)	20.01" (508.3 mm)	15.01" (381.3 mm)	2.25" (57.2 mm)	29.9" (759.5 mm)
E3 Tri-Clamp	3" (internal)	0-234 gpm (0-886 lpm)	0.375" (9.5 mm)	125 psi (8.6 bar)	1.36 gallon (5.1 liter)	20' (6.1 m)	32' (9.8 m)	0.5" NPT	1" NPT	32.01" (813.1 mm)	21.54" (547.1 mm)	16.96" (430.8 mm)	2.31" (58.7 mm)	29.76" (755.9 mm)
V3	3" (internal)	0-220 gpm (0-832 lpm)	0.375" (9.5 mm)	100 psi (7 bar)	1.38 gallon (5.22 liter)	20' (6.1 m)	25' (7.6 m)	0.5" NPT	1" NPT	32" (812.8 mm)	20" (508 mm)	11" (279.4 mm)	2.25" (57.2 mm)	29.75" (755.7 mm)

Note: See service manual for complete specifications

Learn more about Elima-Matic pumps by scanning this QR code with your smartphone.
Need the App? Download any FREE QR App from your devices store.



2" (50.8mm) V2 Metallic Clamped

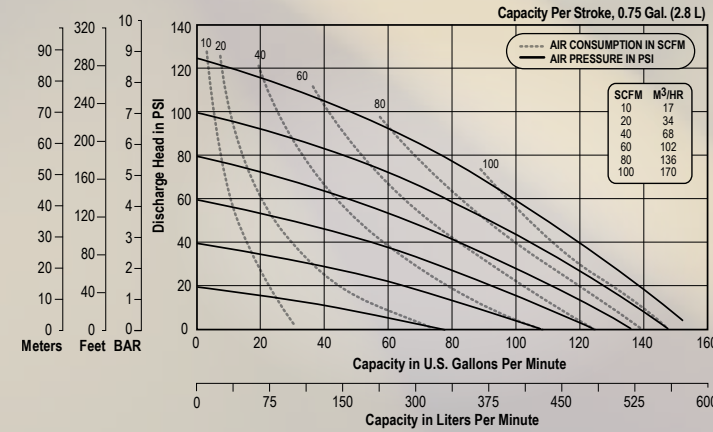

- Max Flow:**
• 152 gpm (575 lpm)
- Porting:**
• Center Horizontal
• Screen Mounted
- Center Section:**
• Metallic (coating options)
- Wetted Section:**
• Aluminum
• Cast Iron
• Stainless Steel

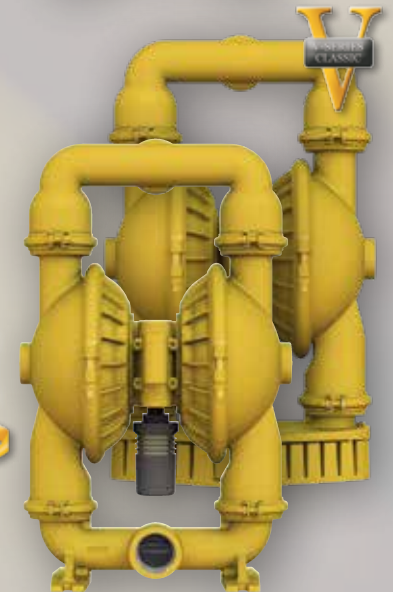
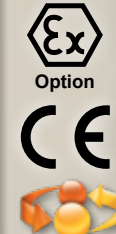

3" (76.2mm) V3 Metallic Clamped

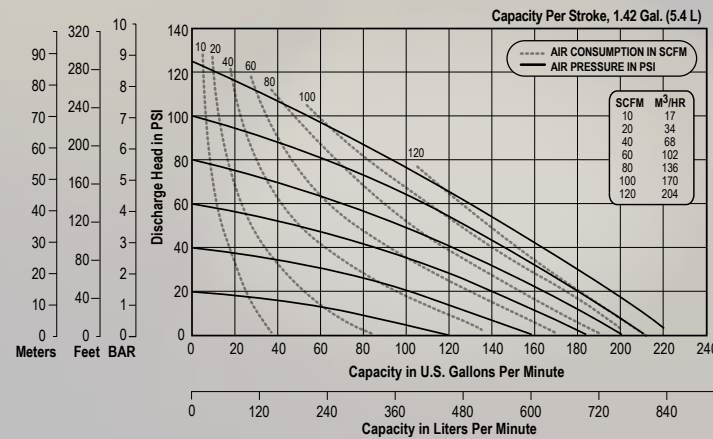

- Max Flow:**
• 220 gpm (832 lpm)
- Porting:**
• Center Horizontal
• Screen Mounted
- Center Section:**
• Metallic (coating options)
- Wetted Section:**
• Aluminum
• Cast Iron
• Stainless Steel

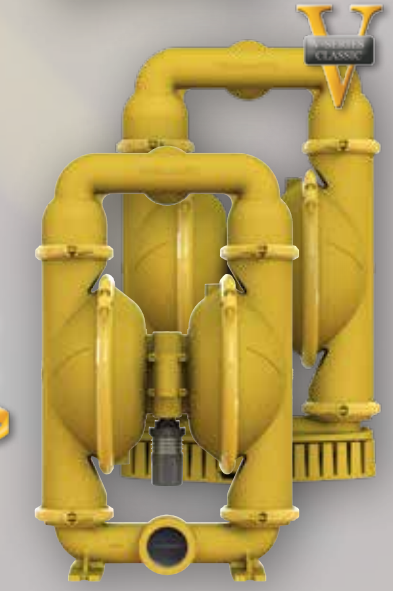
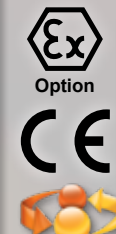

NON-METALLIC BOLTED

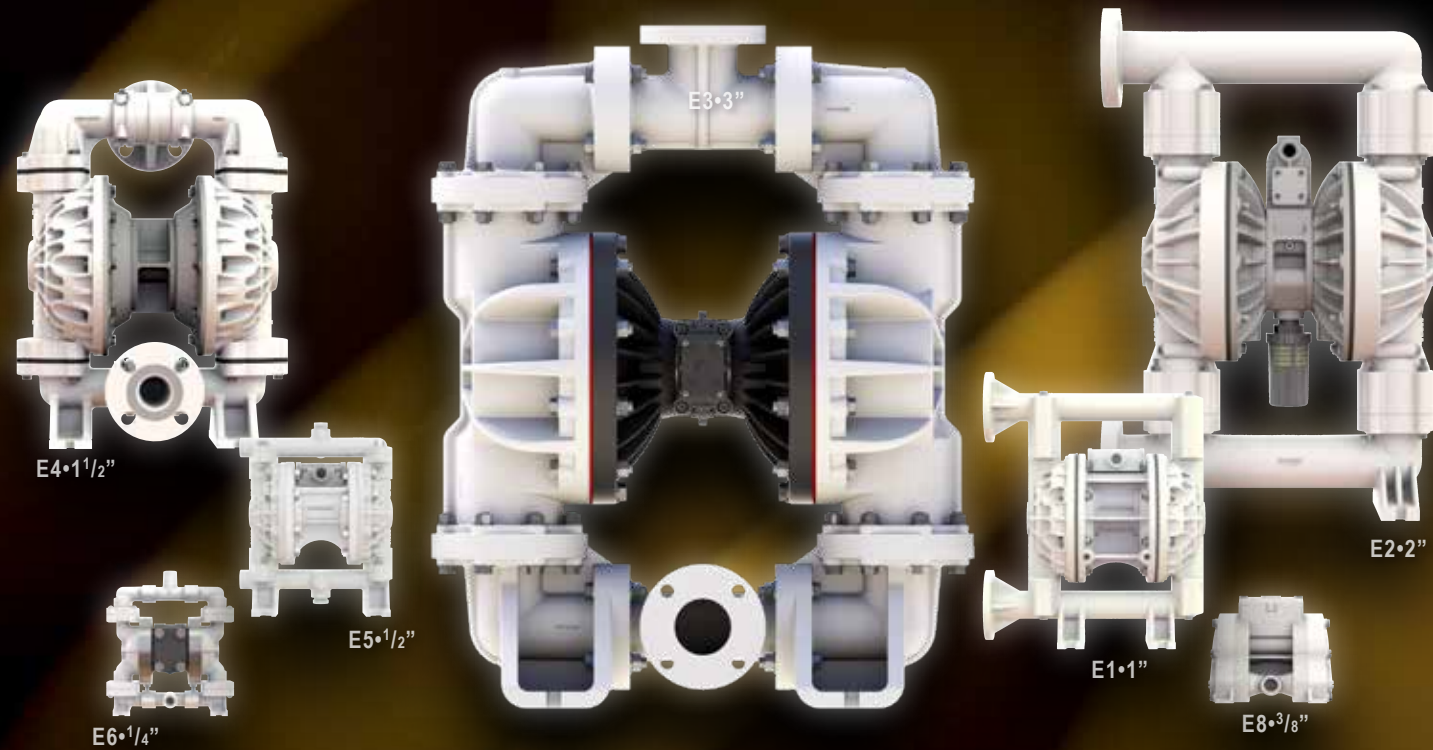

**Superior chemical resistance.
Rugged, leak free construction.**

Features & Benefits:

- Lightweight construction
- Highly chemical resistant
- Wide range of sizes and applications
- Diverse material offering for your applications
- Submersible and portable
- Non-freezing, Non-stalling
- On / Off reliability

Specifications:

- **Sizes:** 1/4" through 3"
- **Wetted Materials:** Polypropylene, PVDF
- **Max Flow Rate:** 238 gpm (901 lpm)
- **Max Suction Lift:** 32' (9.8m) wet
16' (4.9m) dry
- **Max Disp. per Stroke:** 0.9 gallons (3.41 liters)

Non-Metallic Bolted

1/4" (6.4mm) E6 Non-Metallic Bolted

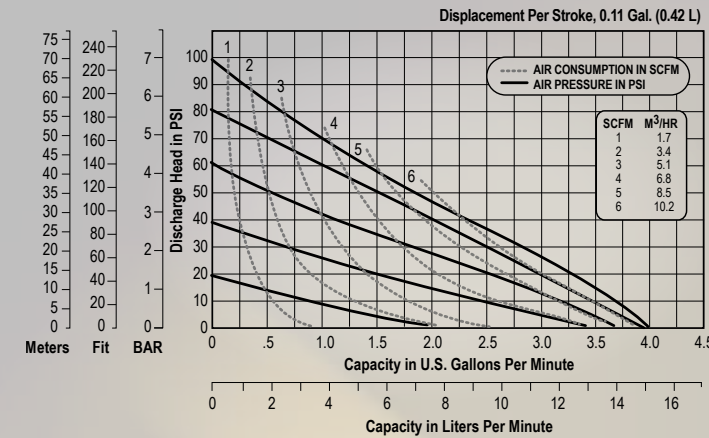

- Max Flow:**
 - 4 gpm (15 lpm)
- Porting:**
 - Center Horizontal
 - Center Vertical
- Center Section:**
 - Acetal
 - Polypropylene
- Wetted Section:**
 - Polypropylene
 - PVDF

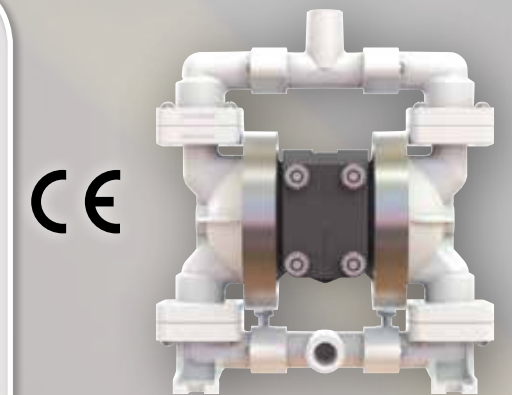

3/8" (8.3mm) E8 Non-Metallic Bolted

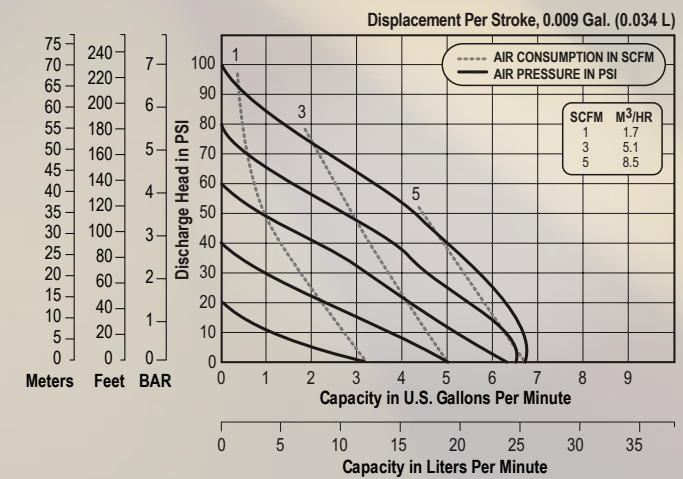

- Max Flow:**
 - 6.8 gpm (26 lpm)
- Porting:**
 - Center Horizontal
 - Center Vertical
- Center Section:**
 - Polypropylene
- Wetted Section:**
 - Polypropylene
 - PVDF

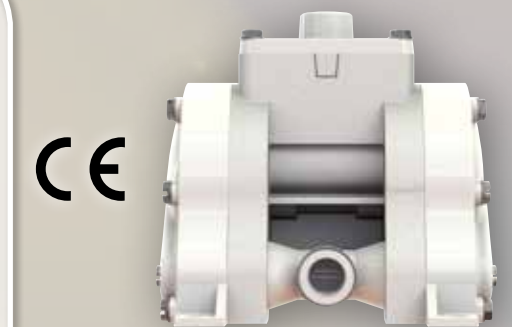

1/2" (12.7mm) E5 Non-Metallic Bolted

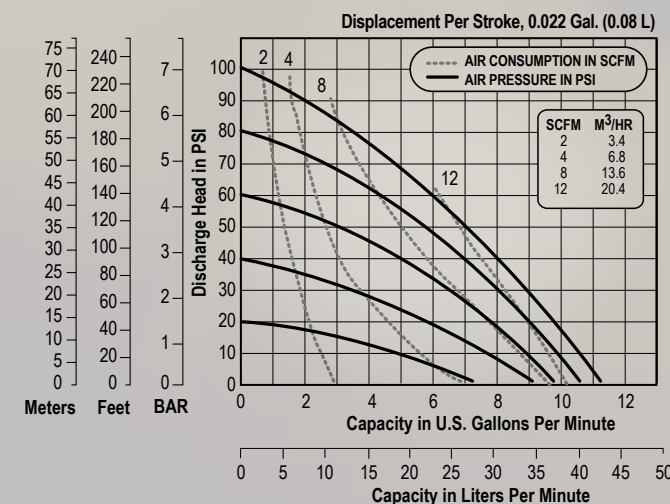

- Max Flow:**
 - 11 gpm (41.6 lpm)
- Porting:**
 - Multiple
- Center Section:**
 - Aluminum
 - Polypropylene
- Wetted Section:**
 - Polypropylene
 - PVDF

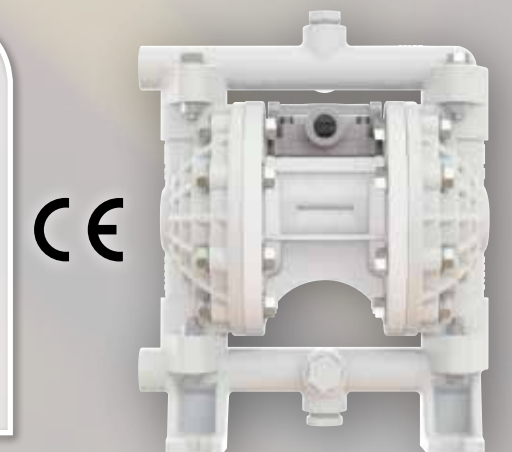

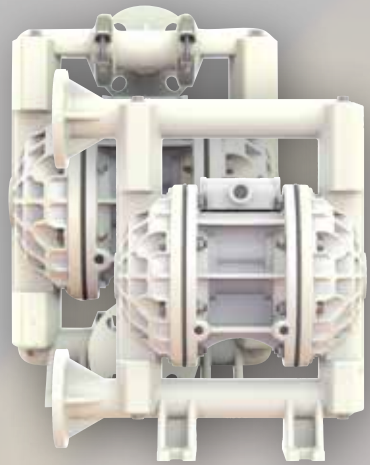

Max Flow:
• 43 gpm (162.8 lpm)

Porting:
• Center Horizontal
• End

Center Section:
• Polypropylene

Wetted Section:
• Polypropylene
• PVDF

1" (25.4mm) E1 Non-Metallic Bolted

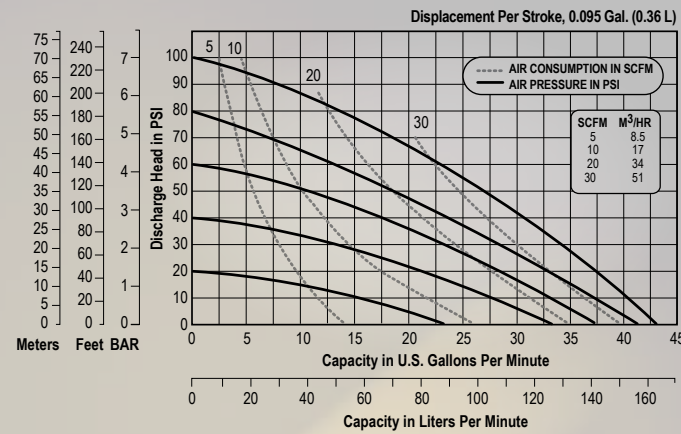

3" (76.2mm) E3 Non-Metallic Bolted

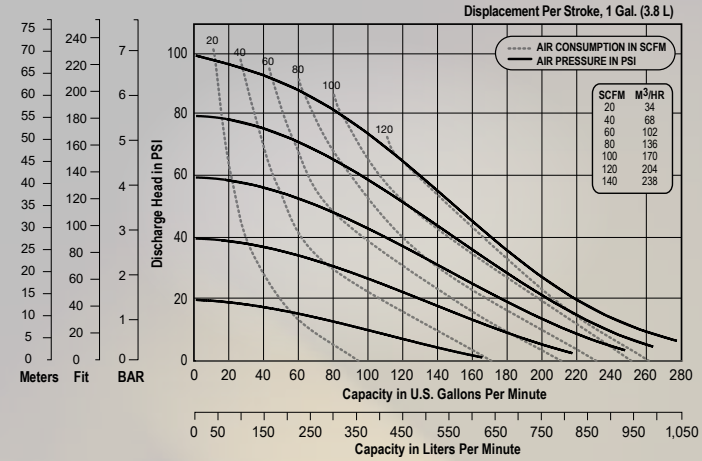

Max Flow:
• 280 gpm (1,060 lpm)

Porting:
• Center Horizontal
• Center Vertical

Center Section:
• Aluminum
(Epoxy Coated)

Wetted Section:
• Polypropylene
• PVDF

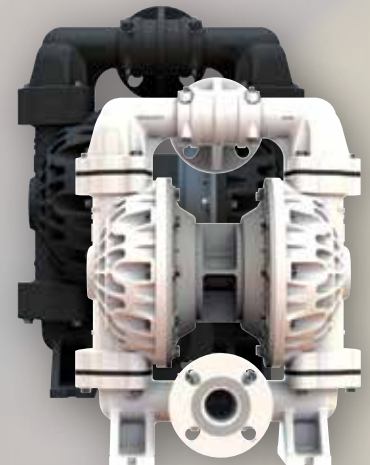
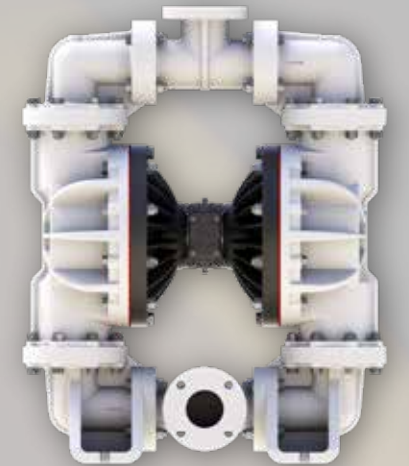

Max Flow:
• 72 gpm (272 lpm)

Porting:
• Center Horizontal
• Center Vertical

Center Section:
• Aluminum

Wetted Section:
• Polypropylene
• PVDF

1 1/2" (38mm) E4 Non-Metallic Bolted

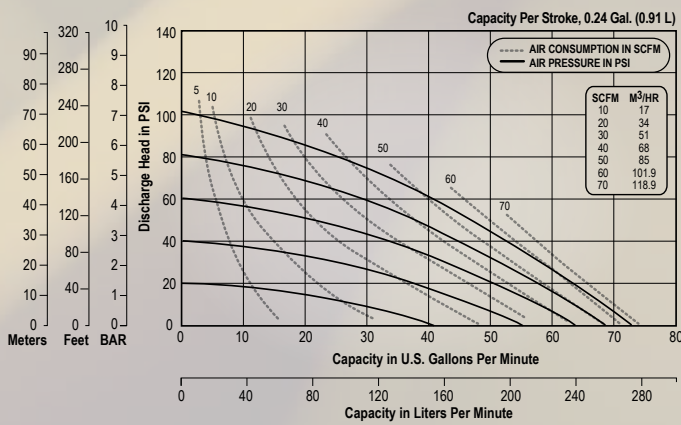

E3 Non-Metallic Bolted Improvements:

- Eliminated spacers between elbows and manifold, reducing the number of potential leak points, less parts
- Replaced Aluminum Center Sections with Polypropylene, improving internal and environmental corrosion resistance and reducing weight
- Increased Maximum Flow Rate from 238 GPM (901 LPM) TO 280 GPM (1,060 LPM)
- Replaced Steel Mounting Feet with Molded Polypropylene, improving environmental corrosion resistance and reducing weight

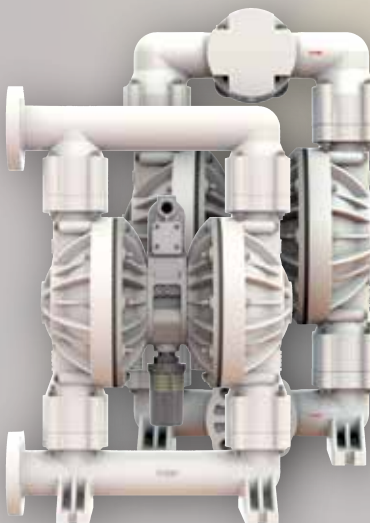

Max Flow:
• 177 gpm (670 lpm)

Porting:
• Center Horizontal
• Center Vertical
• End

Center Section:
• Aluminum
• Polypropylene (U2)
• Stainless Steel

Wetted Section:
• Polypropylene
• PVDF

2" (50.8mm) E2 Non-Metallic Bolted

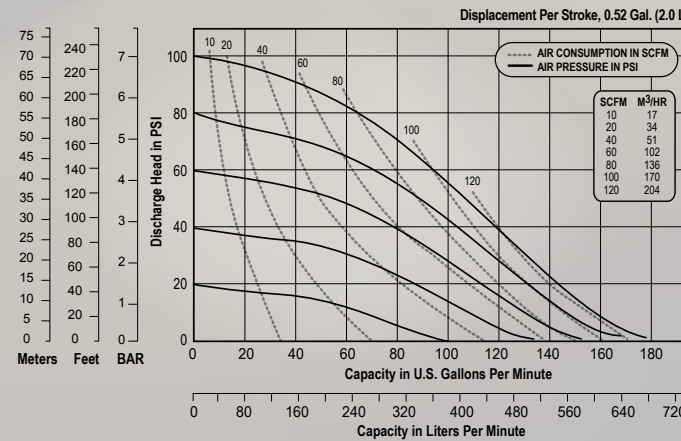

*U2 Polypropylene Center Section Available

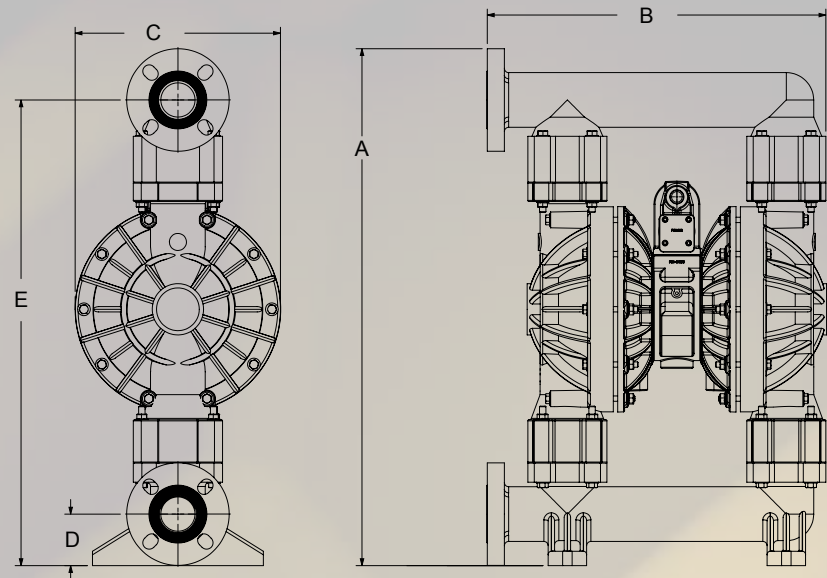

SPECIFICATIONS										DIMENSIONS: Tolerance: ±1/8" (±3mm)				
Pump Model	Port Size	Flow Rate	Solids Handling -Up to-	Head -Up to-	Displacement -Per Stroke-	Suction Lift		Air		A Height	B Width	C Depth	D Base to Center Suction	E Base to Center Discharge
						Dry	Wet	In	Out					
E6	1/4" (internal)	0-4 gpm (0-15 lpm)	0.03125" (1 mm)	100 psi (7 bar)	0.01 gallon (0.04 liter)	5'	n/a	0.25" NPT	0.375" NPT	7.81" (198.4 mm)	7" (177.8 mm)	5.5" (139.7 mm)	0.75" (19.1 mm)	7.81" (198.4 mm)
E8	3/8" (internal)	0-6.8 gpm (0-26 lpm)	0.1" (2.5 mm)	100 psi (7 bar)	0.004 gallon (0.017 liter)	8'	n/a	0.25" NPT	0.25" NPT	5.32" (135 mm)	4.09" (104 mm)	5.72" (145 mm)	0.94" (24 mm)	5.32" (135 mm)
E5	1/2" (internal)	0-11 gpm (0-41.6 lpm)	0.0625" (1.6 mm)	100 psi (7 bar)	0.022 gallon (0.08 liter)	12'	30'	0.375" NPT	0.375" NPT	11.7" (297.2 mm)	9.3" (236.2 mm)	6.25" (158.8 mm)	2.03" (51.6 mm)	10.06" (255.5 mm)
E1-M Center	1" (internal)	0-45 gpm (0-170.3 lpm)	0.125" (3.2 mm)	100 psi (7 bar)	0.11 gallon (0.42 liter)	15'	31'	0.375" NPT	0.5" NPT	16.95" (430.5 mm)	13.52" (343.4 mm)	8.13" (206.5 mm)	2.5" (63.5 mm)	14.77" (375.2 mm)
E1-NM Center	1" (internal)	0-43 gpm (0-162.8 lpm)	0.125" (3.2 mm)	100 psi (7 bar)	0.095 gallon (0.36 liter)	11'	31'	0.375" NPT	0.5" NPT	16.94" (430.3 mm)	13.52" (343.4 mm)	8.13" (206.5 mm)	2.5" (63.5 mm)	14.75" (374.6 mm)
E4	1 1/2" (internal)	0-72 gpm (0-272 lpm)	0.1875" (4.76 mm)	125 psi (8.6 bar)	0.31 gallon (1.17 liter)	15'	25'	0.5" NPT	0.75" NPT	21.6" (549 mm)	15.71" (399 mm)	12.15" (309 mm)	3.22" (82 mm)	18.85" (479 mm)
E2	2" (internal)	0-177 gpm (0-670 lpm)	0.25" (6.3 mm)	100 psi (7 bar)	0.52 gallon (2.0 liter)	16'	32'	0.375" NPT	1" NPT	30.25" (768.4 mm)	19.82" (503.4 mm)	12.01" (305.1 mm)	3.02" (76.7 mm)	27.25" (692.2 mm)
E3	3" (internal)	0-280 gpm (0-1060 lpm)	0.75" (19 mm)	100 psi (7 bar)	1.0 gallon (3.79 liter)	16'	n/a	0.75" NPT	1" NPT	40.66" (1033 mm)	32.31" (821 mm)	16.19" (411 mm)	4.85" (123 mm)	40.66" (1033 mm)

Note: See service manual for complete specifications

VERSAMATIC®

GENUINE PARTS

GENUINE PARTS

Accept No Substitutes

For superior performance, use Versa-Matic Genuine Parts. Our Genuine Parts are engineered to the highest standards and tolerance. There is no substitute for genuine Versa-Matic quality.



GENUINE PARTS



SPECIAL APPLICATIONS FDA



Elima-Matic® food-processing pumps are built with FDA-compliant materials so they can be specified in applications requiring FDA approval.

Features & Benefits:

- Smooth electro polished finish, both internal and external
- Wing nuts models allow simple disassembly
- E-nickel plated air sections or non-metallic (for chemical wash down)
- Tri-clamp connections
- Non-freezing, Non-stalling
- On / Off reliability

Specifications:

- Sizes: 1/2" through 3"
- Materials: Stainless Steel
- Max Flow Rate: 234 gpm (886 lpm)
- Max Suction Lift: 32' (9.8 m) wet
20' (6.1 m) dry
- Max Disp. per Stroke: 1.36 gallons (5.1 liters)

1/2" (12.7mm) E5 Metallic Bolted

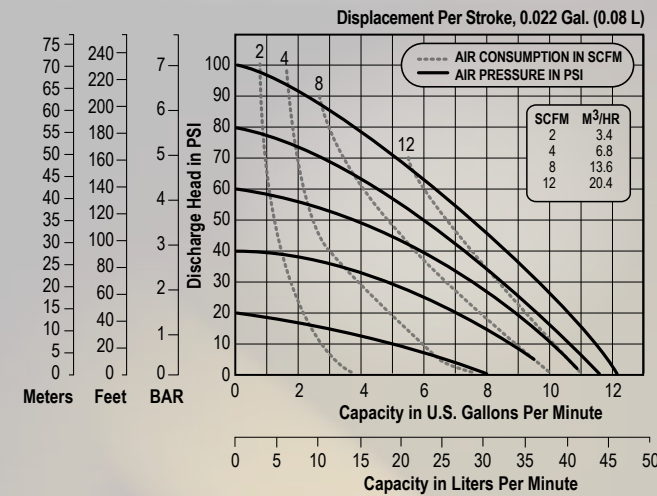

Max Flow:

- 12 gpm (45.4 lpm)

Porting:

- Center Horizontal

Center Section:

- Polypropylene

Wetted Section:

- Stainless Steel

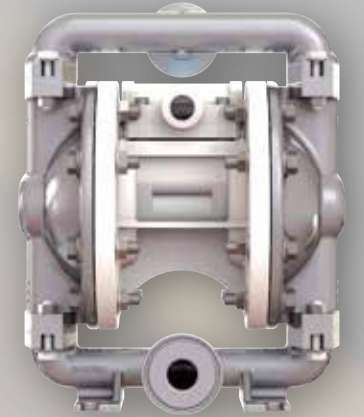

1" (25.4mm) E1 Metallic Bolted

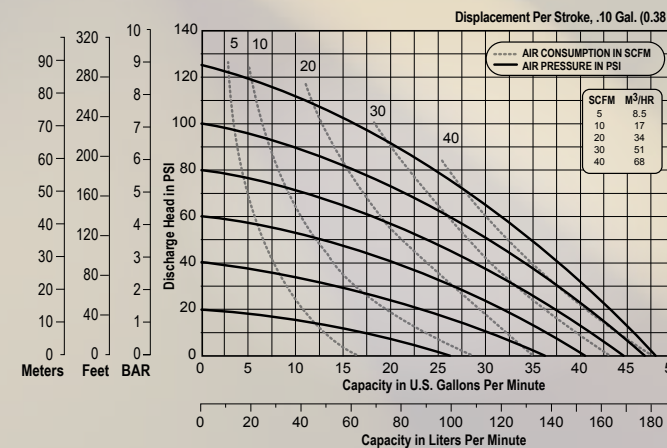

Max Flow:

- 46 gpm (174.1 lpm)

Porting:

- Center Horizontal

Center Section:

- Polypropylene

Wetted Section:

- Stainless Steel

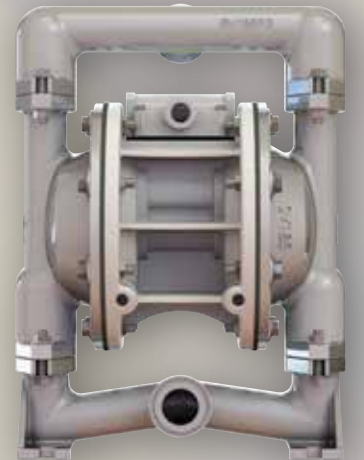

1" (25.4mm) E1 Metallic Bolted

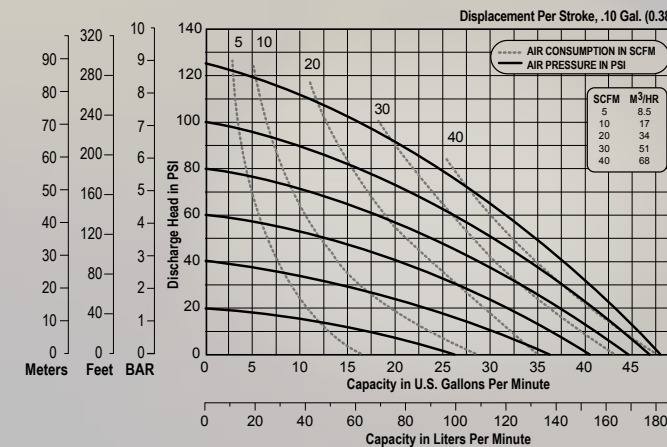

Max Flow:

- 49 gpm (185.5 lpm)

Porting:

- Center Horizontal

Center Section:

- Aluminum (Nickel Plated)

Wetted Section:

- Stainless Steel

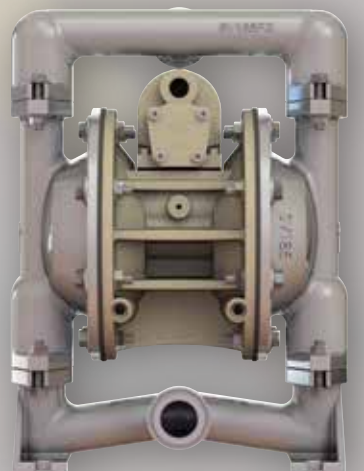

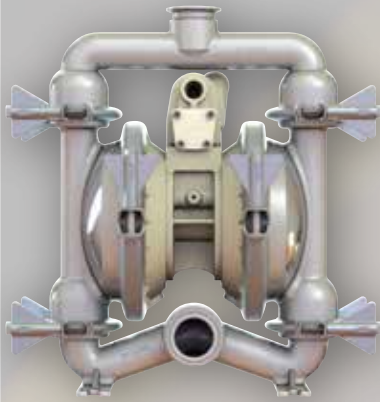

Max Flow:
• 71 gpm (268 lpm)

Porting:
• Center Vertical

Center Section:
• Aluminum (Nickel Plated)

Wetted Section:
• Stainless Steel

1 1/2" (38mm) E4 Metallic Clamped • FDA

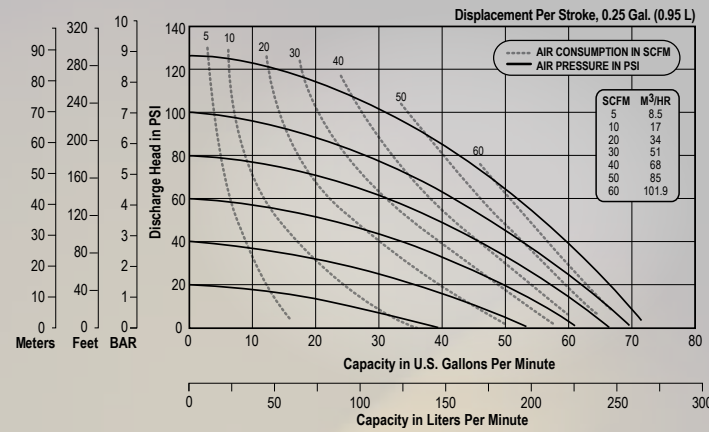

Learn more about FDA pumps by scanning this QR code with your smartphone.
Need the App? Download any FREE QR App from your devices store.

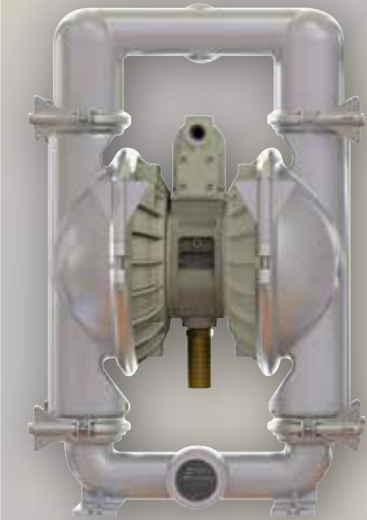
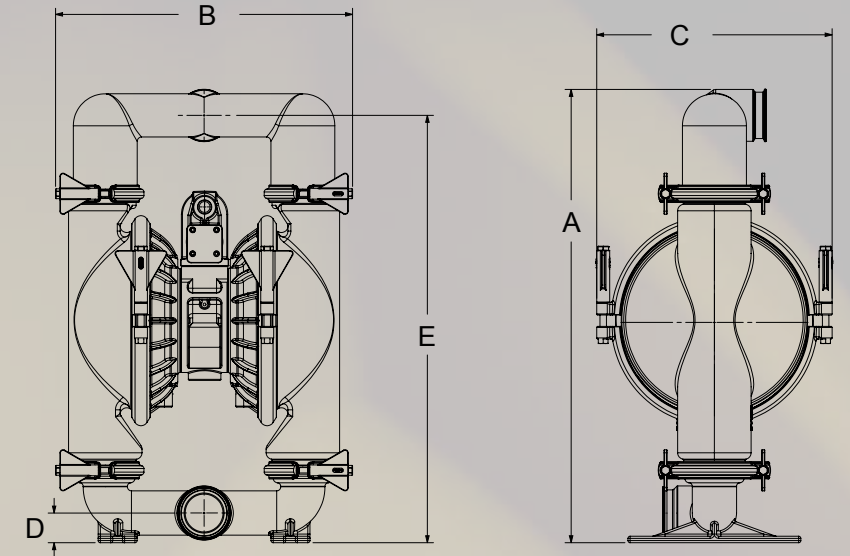

Max Flow:
• 185 gpm (700 lpm)

Porting:
• Center Horizontal

Center Section:
• Aluminum (Nickel Plated)

Wetted Section:
• Stainless Steel

2" (50.8mm) E2 Metallic Clamped

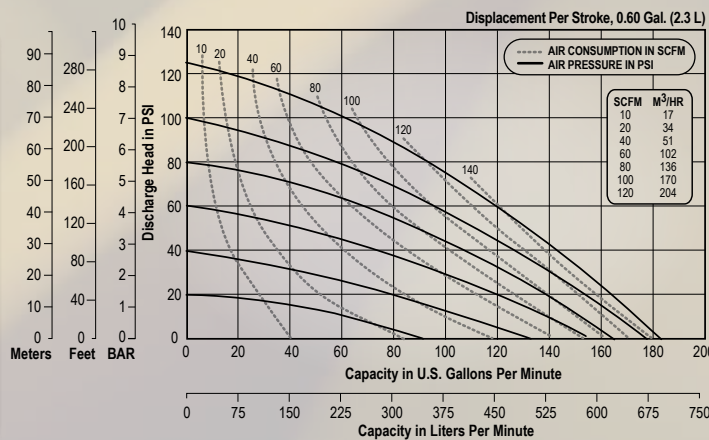

3" (76.2mm) E3 Metallic Clamped

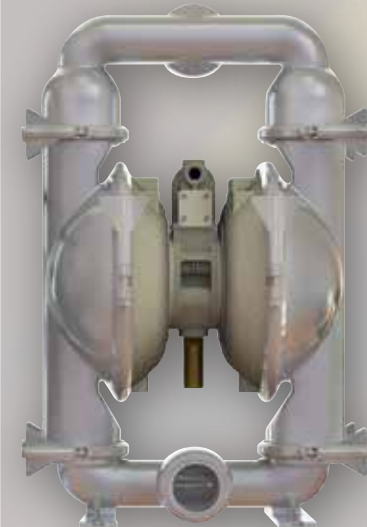
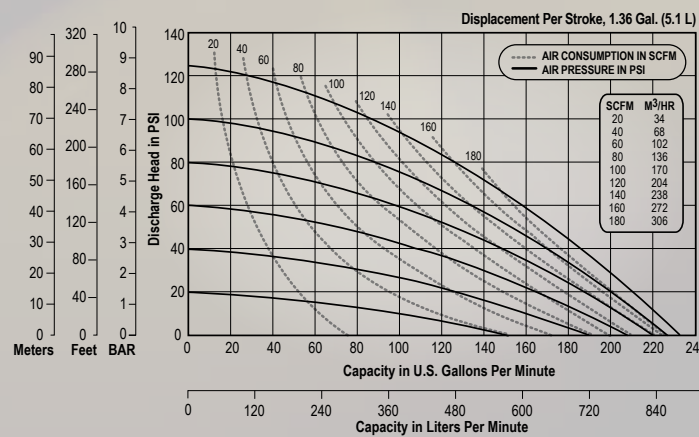

Max Flow:
• 234 gpm (886 lpm)

Porting:
• Center Horizontal

Center Section:
• Aluminum (Nickel Plated)

Wetted Section:
• Stainless Steel

SPECIFICATIONS										DIMENSIONS: Tolerance: ±1/8" (±3mm)				
Pump Model	Port Size	Flow Rate	Solids Handling -Up to-	Head -Up to-	Displacement -Per Stroke-	Suction Lift		Air		A Height	B Width	C Depth	D Base to Center Suction	E Base to Center Discharge
						Dry	Wet	In	Out					
E5	1/2" (internal)	0-12 gpm (0-45.4 lpm)	0.0625 (1.6 mm)	100 psi (7 bar)	0.02 gallon (0.08 liter)	13' (3.9 m)	22' (6.7 m)	0.125" NPT	0.125" NPT	10.4" (264.4 mm)	8.12" (206.3 mm)	6.25" (158.8 mm)	.98" (25 mm)	9.42" (240.3 mm)
E1	1" (internal)	0-46 gpm (0-174.1 lpm)	0.125" (3.2 mm)	100 psi (7 bar)	0.047 gallon (0.18 liter)	16' (4.9 m)	31' (9.4 m)	0.125" NPT	0.5" NPT	14.44" (366.8 mm)	10.72" (272.3 mm)	8.13" (206.4 mm)	1.56" (39.6 mm)	13.63" (346.2 mm)
E1 ATEX	1" (internal)	0-49 gpm (0-185.5 lpm)	0.125" (3.2 mm)	125 psi (8.6 bar)	0.1 gallon (0.38 liter)	16' (4.9 m)	31' (9.4 m)	0.125" NPT	0.5" NPT	14.54" (369.3 mm)	10.72" (272.3 mm)	8" (204.7 mm)	1.65" (42 mm)	13.7" (348.6 mm)
E4	1 1/2" (internal)	0-71 gpm (0-268 lpm)	0.187" (4.76 mm)	110 psi (7.6 bar)	0.31 gallon (1.17 liter)	15' (4.5 m)	25' (7.6 m)	0.5" NPT	0.75" NPT	17.31" (440 mm)	16.51" (419 mm)	11.43" (290 mm)	2.5" (64 mm)	17.31" (440 mm)
E2	2" (internal)	0-185 gpm (0-700 lpm)	0.25" (7.6 mm)	125 psi (8.6 bar)	0.53 gallon (2 liter)	17' (5.1 m)	32' (9.5 m)	0.5" NPT	1" NPT	26.22" (666 mm)	17.18" (436.3 mm)	13.62" (346 mm)	1.72" (43.6 mm)	24.72" (627.8 mm)
E3	3" (internal)	0-234 gpm (0-886 lpm)	0.325" (9.5 mm)	125 psi (8.6 bar)	1.36 gallon (5.1 liter)	20' (6.1 m)	32' (9.8 m)	0.5" NPT	1" NPT	32.01" (813 mm)	21.54" (547 mm)	16.96" (430.6 mm)	2.31" (58.7 mm)	29.76" (755.9 mm)

Note: See service manual for complete specifications

SPECIAL APPLICATIONS

3A Hygienic



Versa-Sense II leak detection unit comes standard on all 3A pumps.



The Elima-Matic hygienic pump has been designed to the 3A Hygienic Standards for Air or Hydraulically Driven Diaphragm Pumps for Milk and Milk Products, Number 44-01.

Features & Benefits:

- High polish finish 32 μ-in (Ra 0.8 μ-m) internal & external
- Designed for CIP (Clean in Place)
- Rotating pump stand for easy draining
- Removable ball cages for cleaning
- Wing nuts for simple disassembly
- Nickel plated or stainless steel (E2 only) air section options for chemical wash down
- Tri-clamp connections

Specifications:

- **Sizes:** 1 1/2" and 2"
- **Materials:** High Polish Stainless Steel
- **Max Flow Rate:** 179 gpm (677 lpm)
- **Max Suction Lift:** 32' (9.8 m) wet
15' (4.6 m) dry
- **Max Disp. per Stroke:** 0.60 gallons (2.27 liters)

1 1/2" (38mm) E4 Metallic Clamped

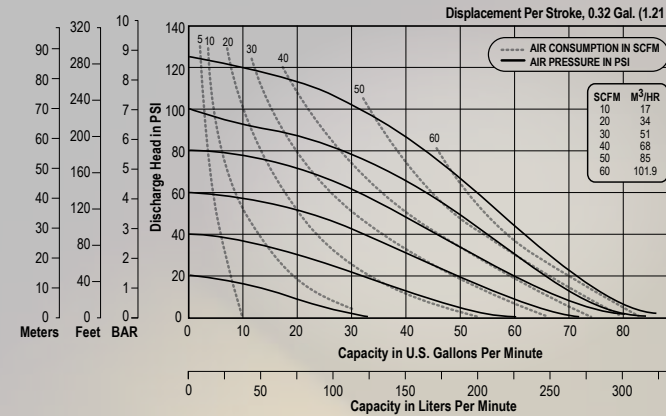

- Max Flow:** • 86 gpm (325 lpm)
- Porting:** • Center Horizontal
- Center Section:** • Aluminum (Nickel Plated)
- Wetted Section:** • Stainless Steel

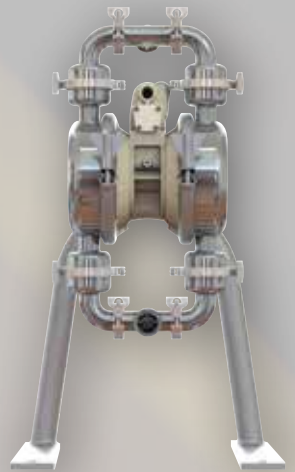

2" (50.8mm) E2 Metallic Clamped

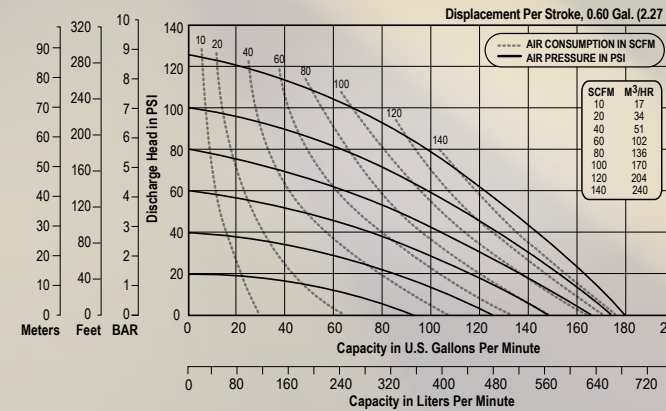

- Max Flow:** • 179 gpm (677 lpm)
- Porting:** • Center Horizontal
- Center Section:** • Aluminum (Nickel Plated)
- Wetted Section:** • Stainless Steel

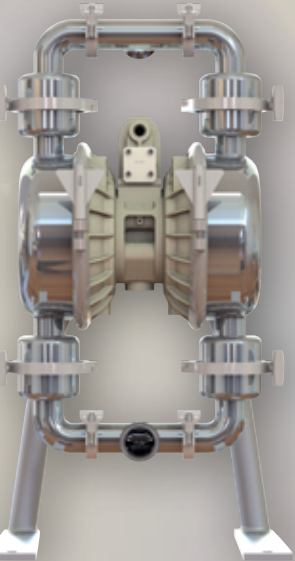

SPECIFICATIONS										DIMENSIONS: Tolerance: ±1/8" (±3mm)				
Pump Model	Port Size	Flow Rate	Solids Handling -Up to-	Head -Up to-	Displacement -Per Stroke-	Suction Lift		Air		A Height	B Width	C Depth	D Base to Center Suction	E Base to Center Discharge
						Dry	Wet	In	Out					
E4	1 1/2" (internal)	0-86 gpm (0-325 lpm)	0.375" (9.5 mm)	125 psi (8.6 bar)	0.31 gallon (1.1 liter)	10' (3 m)	20' (6.1 m)	0.5" NPT	0.75" NPT	31.55" (801.4 mm)	18.57" (472 mm)	15.7" (399 mm)	9.8" (249 mm)	29.8" (757 mm)
E2	2" (internal)	0-179 gpm (0-677 lpm)	0.625" (15.9 mm)	125 psi (8.6 bar)	0.60 gallon (2.27 liter)	15' (4.6 m)	32' (9.8 m)	0.5" NPT	0.75" NPT	34.7" (881.5 mm)	18.57" (472 mm)	17.1" (434 mm)	6.97" (177 mm)	32.63" (829 mm)

Note: See service manual for complete specifications

Learn more about 3A Hygienic pumps by scanning this QR code with your smartphone. Need the App? Download any FREE QR App from your devices store.

3A HYGIENIC

SPECIAL APPLICATIONS

High Pressure 2:1

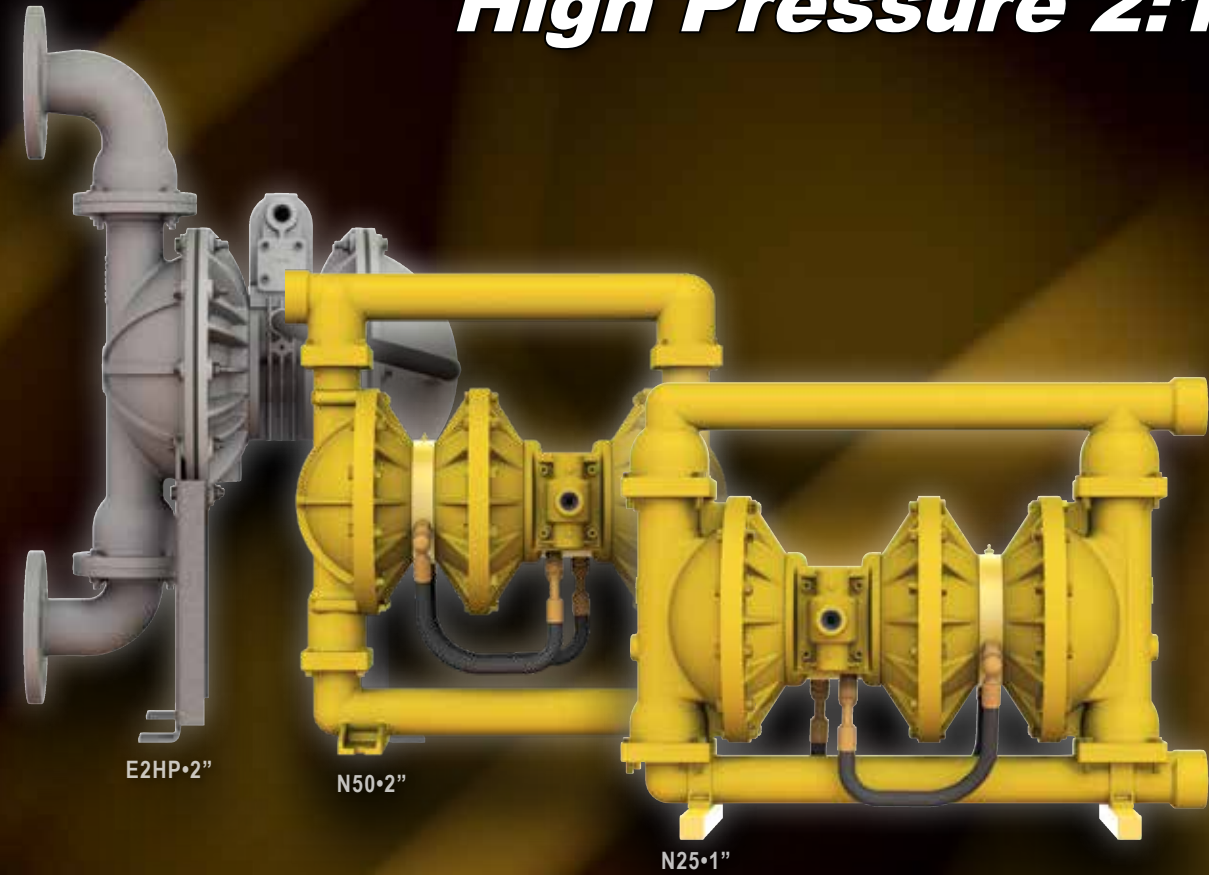

When you simply need more power. The Versa-Matic line of high pressure pumps provides pressures of 200 psi or greater.

Features & Benefits:

- Withstands high pressure for maximum flow control
- Heavy duty construction
- Non-freezing, Non-stalling
- On/Off reliability
- PTFE fitted units available

Specifications:

- **Sizes:** 1" through 2"
- **Wetted Materials:** Aluminum, Stainless Steel
- **Max Flow Rate:** 90 gpm (341 lpm)
- **Max Suction Lift:** 25' (7.6 m) wet
20' (6 m) dry
- **Max Disp. per Stroke:** 0.7 gallons (2.6 liters)

1" (25.4mm) N25 Metallic Bolted

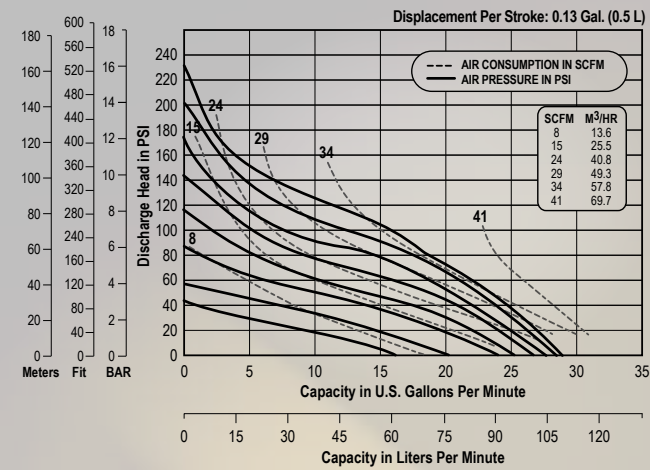

Max Flow:

- 30 gpm (113.5 lpm)

Porting:

- End

Center Section:

- Aluminum (coating options)

Wetted Section:

- Stainless Steel
- Aluminum

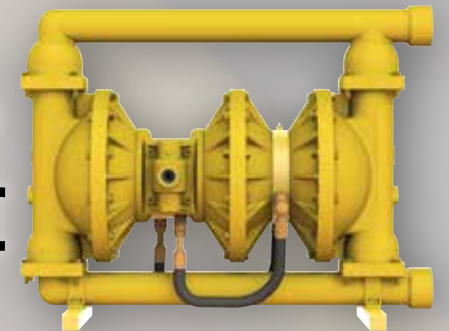

2" (50.8mm) N50 Metallic Bolted

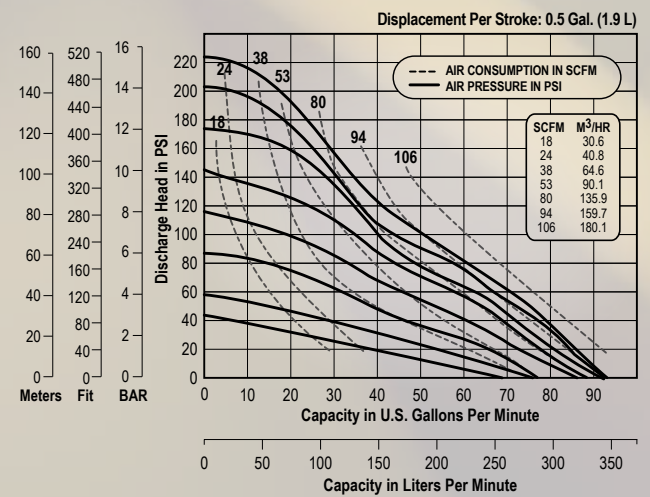

Max Flow:

- 90 gpm (341 lpm)

Porting:

- End

Center Section:

- Aluminum (coating options)

Wetted Section:

- Stainless Steel
- Aluminum

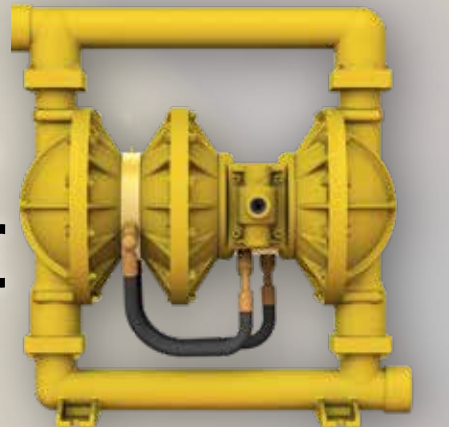

2" (50.8mm) E2HP Metallic Bolted

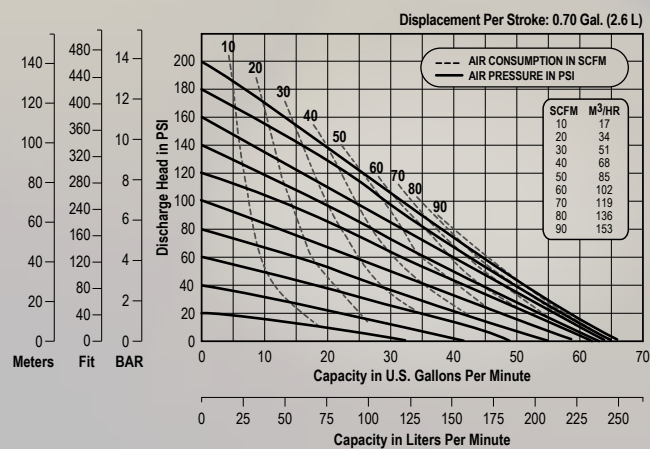

Max Flow:

- 69 gpm (261.1 lpm)

Porting:

- End

Center Section:

- Aluminum (coating options)

Wetted Section:

- Stainless Steel

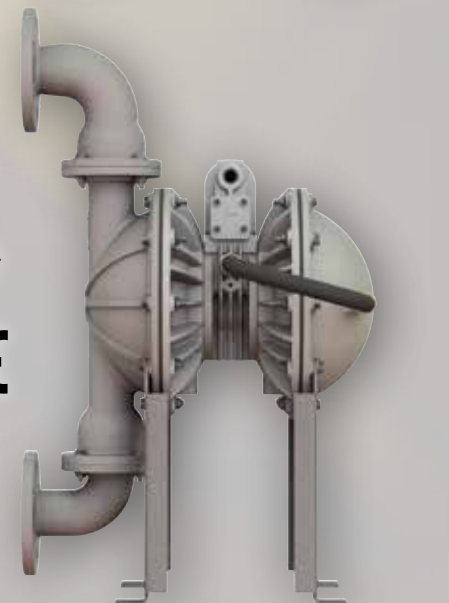

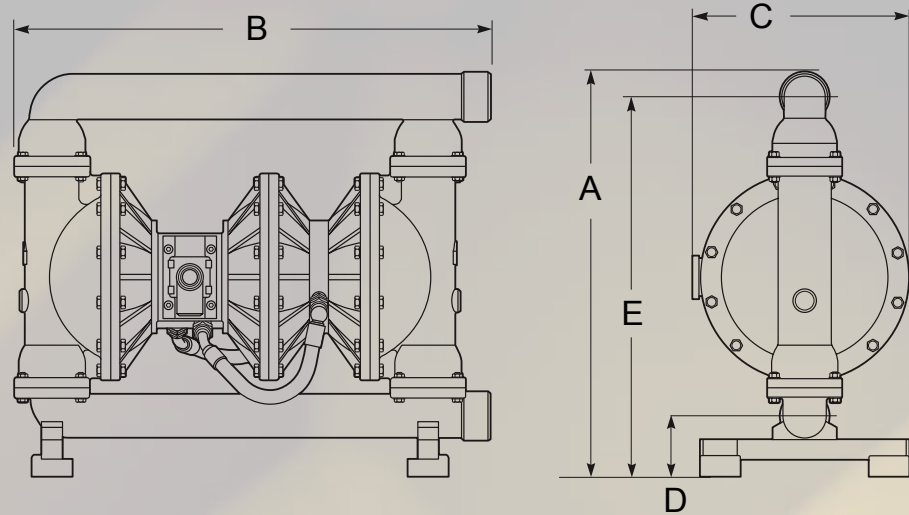

SPECIFICATIONS								DIMENSIONS: Tolerance: ±1/8" (±3mm)						
Pump Model	Port Size	Flow Rate	Solids Handling -Up to-	Head -Up to-	Displacement -Per Stroke-	Suction Lift		Air		A Height	B Width	C Depth	D Base to Center Suction	E Base to Center Discharge
						Dry	Wet	In	Out					
N25	1" (internal)	0-30 gpm (0-113.5 lpm)	0.125" (3 mm)	240 psi (16.5 bar)	0.13 gallon (0.5 liter)	20' (6 m)	25' (7.6 m)	0.5" NPT	0.375" NPT	15.94" (405 mm)	18.27" (464 mm)	11" (280 mm)	2.45" (62.2 mm)	15.44" (392.2 mm)
N50	2" (internal)	0-90 gpm (0-341 lpm)	0.25" (6 mm)	240 psi (16.5 bar)	0.5 gallon (1.9 liter)	20' (6 m)	25' (7.6 m)	0.75" NPT	0.75" NPT	24.41" (620 mm)	28.7" (729 mm)	12.6" (320 mm)	5.12" (130 mm)	24.41" (620 mm)
E2HP	2" (internal)	0-69 gpm (0-261.1 lpm)	0.25" (6 mm)	200 psi (13.8 bar)	0.7 gallon (2.6 liter)	20' (6 m)	25' (7.6 m)	0.5" NPT	1" NPT	30.6" (778 mm)	18.2" (463 mm)	11.7" (297 mm)	4.3" (109 mm)	23.1" (587 mm)

Note: See service manual for complete specifications



Learn more about High Pressure pumps by scanning this QR code with your smartphone.
Need the App? Download any FREE QR App from your devices store.

SERVICE MANUALS & DATA SHEETS

Improved Features:

- Simplified readability
- Larger drawings
- Consistent look and feel
- Tabs for easy navigation

24/7 Availability

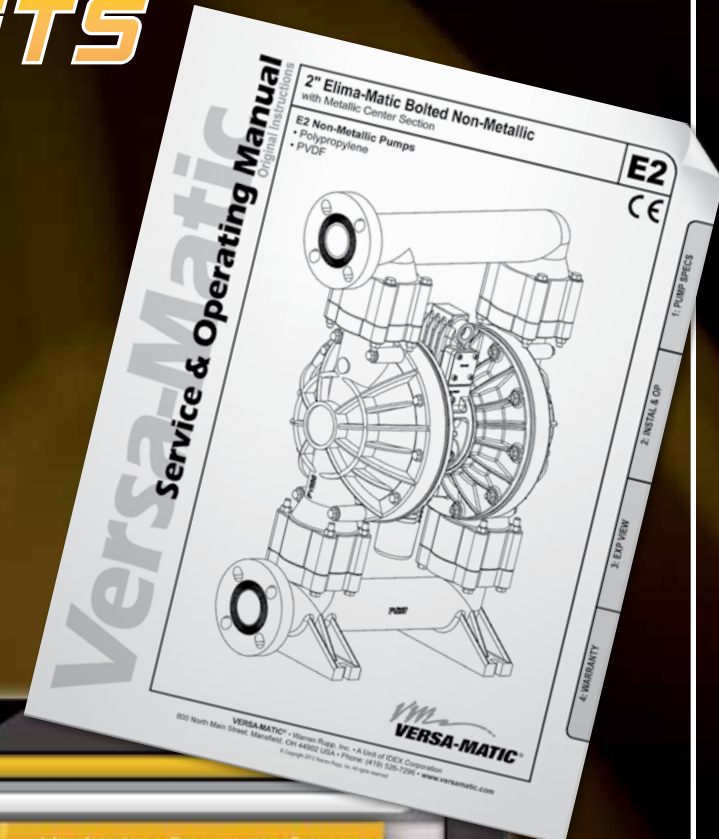

SPECIAL APPLICATIONS Centrifugal

2 CONNECTION OPTIONS Place your order today

NPT: SPA15 or SPA15-APP
BSP: SPA15-BSP or SPA15-BSP-APP

- Add -APP to the end of part number for 2 pole connector



SludgeMaster•3"

Reliable submersible pumps that deliver a wide range of options, from size to pressure to flow rate.

Features & Benefits:

- Lightweight, portable and submersible
- Used for a wide range of applications
- Self-lubricating and easy to maintain
- No priming
- Long lasting performance
- Run-dry capable
- Self-draining
- Handles abrasives with less water

Specifications:

- **Sizes:** 1 1/2" and 3"
- **Wetted Materials:** Aluminum
- **Max Flow Rate:** 300 gpm (1,135.6 lpm)
- **Max Weight:** 56 lbs. (26.76 kg)
- **Kit:** Add _KIT to any model for carrying case and hose assembly.



1 1/2" (38mm) Porta-Matic

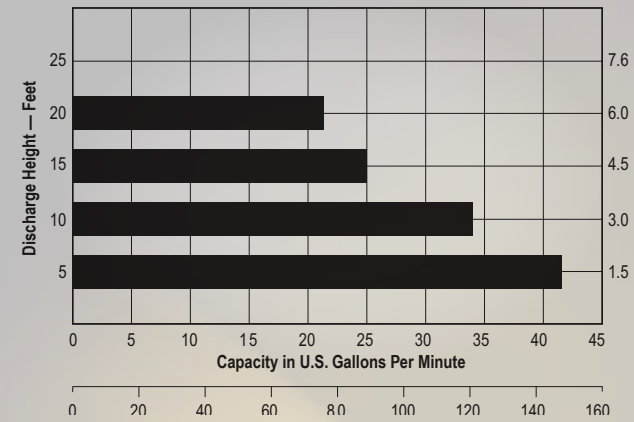

- Max Flow:** • 43 gpm (162.8 lpm)
- Porting:** • Vertical
- Non-Wetted Section:** • Aluminum (coating options)
- Wetted Section:** • Aluminum



3" (76.2mm) SludgeMaster

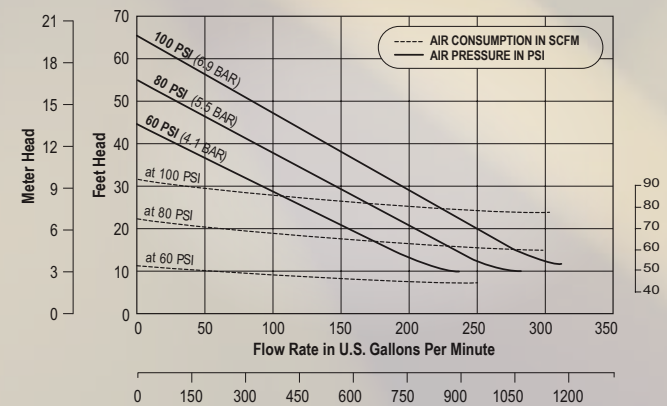

- Max Flow:** • 300 gpm (1135.6 lpm)
- Porting:** • Vertical
- Non-Wetted Section:** • Aluminum (coating options)
- Wetted Section:** • Aluminum

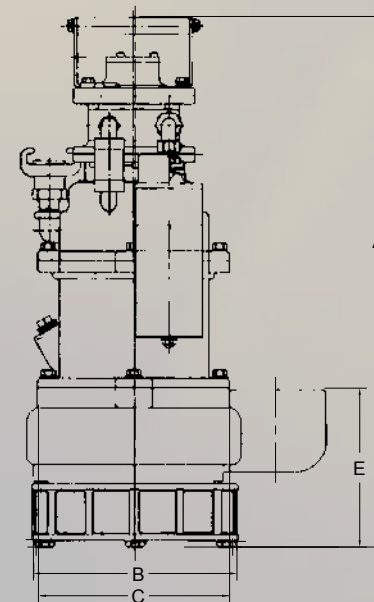

SPECIFICATIONS						DIMENSIONS: Tolerance: ±1/8" (±3mm)			
Pump Model	Port Size	Flow Rate	Solids Handling -Up to-	Head -Up to-	Weight	A Height	B Width	C Depth	D Base to Center Discharge
Por-ta-Matic	1 1/2" (internal)	0-43 gpm (0-162.8 lpm)	0.38" (9.5 mm)	20'	33 lbs. (14.76 kg)	22.04" (559.8 mm)	8.875" (225.4 mm)	6.19" (157.2 mm)	4.71" (119.6 mm)
Sludge-Master	3" (internal)	0-300 gpm (0-1135.6 lpm)	1.5" (38 mm)	65'	56 lbs. (26.76 kg)	23.51" (597.2 mm)	13" (330.2 mm)	9.02" (229.1 mm)	7.11" (180.6 mm)

Note: See service manual for complete specifications

Learn more about Centrifugal pumps by scanning this QR code with your smartphone. Need the App? Download any FREE QR App from your devices store.

CENTRIFUGAL



ACCESSORY BENEFITS:

- Enhanced pump performance and productivity
- Extend MTBF (Mean Time Between Failure)
- Protect ancillary equipment in the fluid flow path
- Enhanced safety and environmental responsibility
- Precision pump control and air efficiency
- All Versa-Matic accessories are tested to the highest standards

Leak Detection

- **Electronic:** Warning lights, audible alarm and pump shut down options.
- **Visual:** LED light.

Level Controls

Float actuated, all-pneumatic operation. Ideal for sump and liquid transfer. Opens and closes pump air supply for positive response. Up to 125 cfm, pressure drops <10 psi.

Stabilizers

Blacoh® Senty® inlet stabilizers. Reduces pressure fluctuations and assists pump head filling during each inlet stroke. In high suction applications, stabilizer will momentarily maintain the flow of the accelerated fluid.

Filters / Regulators

Clean, dry air is key to trouble-free pump operation. Modular for easy installation and servicing.

Surge Suppressors

Provide virtually pulse-free discharge flow, for steadier pressure with less system vibration and noise. Self-charging and self-venting. Learn more on page 46.

Valves

Polypropylene: Precision molded ball valves reinforced with fiberglass for additional strength. Stainless Steel (316): Two piece ball valves. Blow-out proof stems, rated at 1000 psi.

Air Dryer

Enhance the life and performance of your pneumatic equipment. This point-of-use dryer removes 99% of water, rust and contaminants in air lines.

Mufflers

Sound dampening mufflers in a full array of materials and sizes. Effectively reduce pump decibel levels to recommended safety levels. Can be sold for a wide variety of pneumatic equipment.

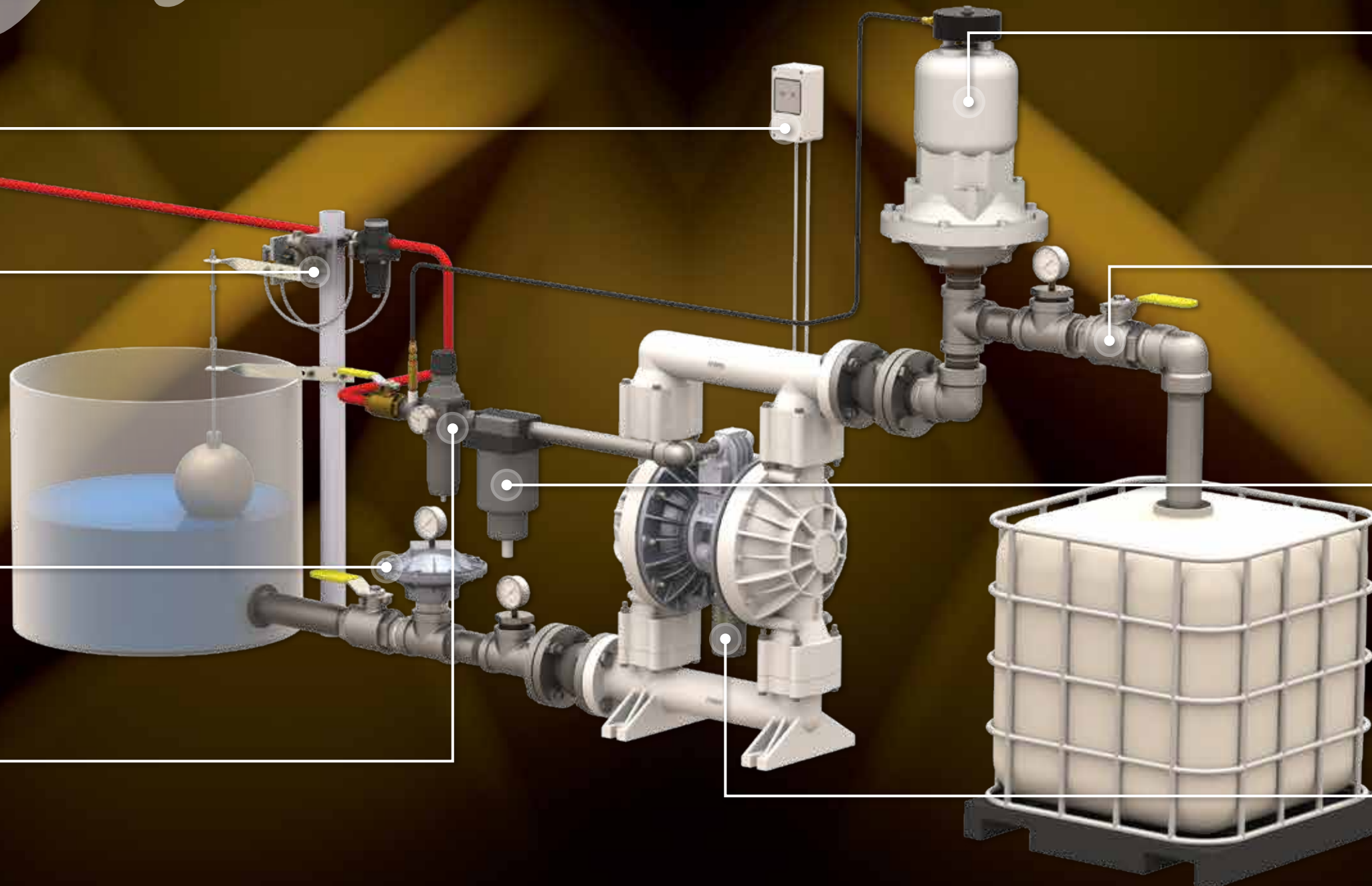

Accessories: Surge Suppressors

Steady Your Flow

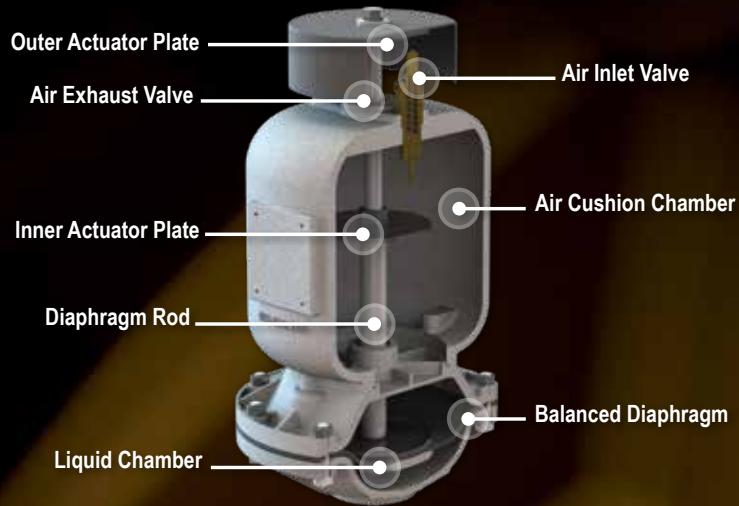

Pump Cycling Rate



Surge Suppressor Advantages:

- Virtually surge-free flows
- Steadier pressures
- Less vibration and noise
- Simple installation
- Variety of sizes and materials
- Automatically self-charging and self-venting
- Longest life balanced diaphragm



Model & Description	Max. Pressure	Air Inlet Size	Liquid Inlet Size	Dimensions inches (mm)	Available Wetted Materials										
					Chamber				Diaphragm						
					Aluminum	Stainless Steel	Cast Iron	Alloy C	Neoprene	Nitrile	FKM	EPDM	Neoprene w/ PTFE Overlay	Santoprene®	
VTA1 For 1" pumps. Includes 13 1/4" air hose	125 psi 8.6 bar	1/4" NPT (external thread)	1" NPT	13 5/8"-15 1/8" H (346mm-384mm) 9" diameter (229mm) NPT(F)	✓	✓				✓	✓	✓	✓	✓	✓
VTA25 For 1" pumps. Includes 13 1/4" air hose	125 psi 8.6 bar	1/4" NPT (external thread)	1" BSP (Tapered int. thread)	13 5/8"-15 1/8" H (346mm-384mm) 9" diameter (229mm) NPT(F)	✓	✓				✓	✓	✓	✓	✓	✓
VTA1 1/2 For 1" & 1 1/2" pumps. Includes 11 1/4" air hose	125 psi 8.6 bar	1/4" NPT (external thread)	1 1/2" NPT (int. thread)	19 7/8"-21 3/8" H (505mm-543mm) 10 1/2" diameter (267mm) NPT(F)	✓	✓	✓	✓		✓	✓	✓	✓	✓	✓
VTA40 For 1" & 1 1/2" pumps. Includes 11 1/4" air hose	125 psi 8.6 bar	1/4" NPT (external thread)	1 1/2" BSP (Tapered int. thread)	19 7/8"-21 3/8" H (505mm-543mm) 10 1/2" diameter (267mm) NPT(F)	✓	✓	✓	✓		✓	✓	✓	✓	✓	✓
VTA2 DL2 For 1 1/2" & 2" pumps. Includes 13 1/4" air hose CE	125 psi 8.6 bar	1/4" NPT (external thread)	2" NPT (int. thread)	20 1/4"-23 3/16" H (514mm-589mm) 12 1/2" diameter (317mm) NPT(F)	✓	✓	✓	✓		✓	✓	✓	✓	✓	✓
VTA50 DL2 For 1 1/2" & 2" pumps. Includes 13 1/4" air hose CE	125 psi 8.6 bar	1/4" NPT	2" BSP (Tapered int. thread)	20 1/4"-23 3/16" H (514mm-589mm) 12 1/2" diameter (317mm) NPT(F)	✓	✓	✓	✓		✓	✓	✓	✓	✓	✓
VTA3 DL2 For 3" pumps. Includes 13 1/4" air hose CE	125 psi 8.6 bar	1/4" NPT	3" 150# ANSI flange or 3" NPT int.	20 1/8"-23 1/8" height (511mm-587mm) 16 3/16" diameter (411mm) NPT(F)	✓	✓	✓			✓	✓	✓	✓	✓	✓
VTA80 DL2 For 3" pumps. Includes 13 1/4" air hose CE	125 psi 8.6 bar	1/4" NPT	3" BSP (Tapered int.) or 80mm DIN Flange	20 1/8"-23 1/8" H (511mm-587mm) 16 3/16" diameter (411mm) NPT(F)	✓	✓	✓			✓	✓	✓	✓	✓	✓
VDA05 CE	125 psi 8.6 bar	1/2" NPT	1/2" NPT	7 15/32" H (190mm) 5 9/8" W (143mm) 6 15/16" D (176mm)	Aluminum, Stainless Steel & Polypropylene										
VDA07 CE	125 psi 8.6 bar	1/4" NPT	3/4" NPT	7 23/32" H (196mm) 5 9/8" W (143mm) 6 15/16" D (176mm)	Polypropylene only										
VDA10 CE	125 psi 8.6 bar	1/4" NPT	1" NPT	11 23/32" H (298mm) 5 9/8" W (143mm) 7 1/2" D (191mm)	Polypropylene only										

Accessories:

Value Added Products



Liquid Level Control

Versa-Matic's float actuated Liquid Level Control unit automatically opens and closes air supply to your pump, bringing the following benefits to your process:

- 1). **Pneumatic** - No electrical power required,
- 2). **Adjustable** - Operating range from inches to 9' (2.7m),
- 3). **Reliable** - Stainless steel float and rod,
- 4). **Safe** - ATEX compliant,
- 5). **Universal** - Can be used on all AODD pumps

Mufflers

Effective sound dampening for Versa-Matic pumps. Mufflers are a rugged Polymer or metallic housing. Sound dampening and encapsulated mufflers have replaceable acoustic composite inserts. Versa-Matic pumps are supplied with a basic muffler. Meets OSHA dBA requirements.

Anti-Shock Valves

Protect your pumps, pipes and diaphragms from damage during start-ups. Our Smart Start Anti-shock valves enable compressed air to gradually increase to the desired pressure over a time period of up to 30 seconds.

Drum & Pail Transfer Kits

The adaptor kits are constructed of chemically-resistant materials to handle the job. Plastic pipe assembly comes complete with all the hardware needed. Simply attach the threaded end to the suction manifold and lower it into the liquid source. The 55-gallon Drum Transfer Kit includes pump support legs to minimize the vibration occurring in a diaphragm pump. The 120# Barrel Transfer Kit includes a lid with adjustment screws for a snug fit every time.



Versa-Matic is an innovation leader in diaphragm and materials technologies. Since releasing the patented extended life Versa-Dome™ diaphragm and TPE-XL (Santoprene®), both AODD industry firsts, Versa-Matic has been known as an innovative solutions provider. This tradition continues with the release of the FUSION PTFE bonded product offering.

Now Available In 3"

FUSION™

FUSION™ Technology

Extended Flex Life

- Oversized integrated plate supports nearly 50% of the diaphragm through the entire dynamic motion
- No outer plate to wear diaphragm or to trap abrasive particles
- Deflection ridges prevent flex points and eliminate radial cracking
- Back up ribs support and guide the diaphragm with each flex

No Leak Paths

- No center hole or torque required, superior leak free operation and installation

Cleanability

- No outer plate to trap particles for easy cleaning and sanitation

Sizes Available:

- ½", 1", 1½", 2" and 3" diaphragms

VERSA-DOME™

VERSA-DOME™ Technology

Extended Flex Life

- Dome shape allow the diaphragm to roll, spreading the wear across the entire face
- No complex angles to create stress / wear points
- Low start up pressure reduces diaphragm stress
- Dome shape delivers full stroke and excellent displacement, creating flow with less strokes compared to competitive alternatives (Wilden® UF)

Ease of Installation

- The flexible dome shape make them simple to invert and install without the use of special tools or pry bars

Interchangeable Upgrade

- 2" and 3" kits are available to upgrade the performance of Wilden® pump units

Sizes Available:

- 2" and 3" diaphragms

VERSA-RUGGED™

VERSA-RUGGED™ Technology

Solids and Slurries Handling

- The oversized outer plates leave less diaphragm exposed to solids in fluid
- Preferred for high suction lift and positive suction conditions
- Support from large diaphragm plates increases flex life in many poor operating conditions

Interchangeable

- 1½", 2", and 3" diaphragms fit into many Wilden® pump units

Sizes Available:

- ½", 1", 1½", 2" and 3" diaphragms

2-PIECE

2-Piece Design

Classic Performance

- Proven performance

Interchangeable

- 1½", 2", and 3" diaphragms fit into many Wilden® pump units

Sizes Available:

- ½", 1", 1½", 2" and 3" diaphragms

Please consult your distributor or factory experts for additional details.

Diaphragm Selection Guide

Diaphragm Material	Fluid Characteristics					Installation/Duty Cycle				Repair
	Water	Suspended Solids	Erosive/Abrasive Fluids	High Viscosity Fluids	Standard Fluids	Flooded Suction	Suction Lift	Intermittent	Continuous	Maintenance
FUSION PTFE	A+	A+	C+	A+	A+	A+	A	A+	A+	A+
VERSA-DOME (PTFE/Rubber)	A+	A	A	B+	A+	A	A	A+	A+	A+
VERSA-RUGGED (PTFE/Rubber)	A	A+	A+	A	A	A+	A+	A	B+	B+
2-PIECE PTFE	A	B+	C	B	A	A	B+	A	B+	B+

A+ = Best • F = Not Recommended

For reference only, consult distributor

Materials Selection Guide

Diaphragm Material	Purchase Price	Flex Life	Abrasion Resistance	Chemical Resistance	Temp. Limitations	Temp. Max. Operating	Temp. Min. Operating
Nitrile	A	A-	B	C+	C	190°F/88°C	-10°F/-23°C
EPDM	B	B	B+	B+	B+	280°F/138°C	-40°F/-40°C
Hytrel®	B-	A	A+	B+	B	220°F/104°C	-20°F/-29°C
Neoprene	A+	A	B	D	C	200°F/93°C	-10°F/-23°C
PTFE	D	C-	F	A+	A	220°F/104°C	-35°F/-37°C
Santoprene®	A+	A+	A+	A	A+	275°F/135°C	-40°F/-40°C
FKM	F	D	C	A	A+	350°F/177°C	-40°F/-40°C

A+ = Best • F = Not Recommended

For reference only, consult distributor

Nordel® is a registered tradename of The Dow Chemical Company • Santoprene® is a registered tradename of Exxon Mobil Corp.
Hytrel® is a registered tradename of E.I. DuPont • Kynar® is a registered tradename of Arkema

Non-Metallic Pumps

Model:	E6 • ¼"	E8 • ⅜"	E5 • ½"	E1 • 1"	E4 • 1½"	E2 • 2"	E3 • 3"
Clamped Design	●●●						
Bolted Design		●●	●●●	●●	●●	●●	●●
Side Discharge			●●		●●		

● Polypropylene ● PVDF Kynar®

Metallic Pumps

Model:	E5 • ½"	E7 • ¾"	E1 • 1"	E4 • 1½"	E40 • 1½"	E2 • 2"	E3 • 3"
Clamped Design				●●●●		●●●●	●●●●
Bolted Design	●●●	●	●●●	●●	●●●	●●●●	●●●
Food Processing	●		●	●		●	●
Sanitary				●		●	
Flap Valve						●	
Screen Mounted				●		●	●
High Pressure						●	
ATEX Compliant	●●●	●	●●●	●●●●	●●●●	●●●	●●●●

● Aluminum ● Cast Iron ● Hastelloy C ● Stainless Steel

Diaphragms, Valve Balls, Seats & O-Rings

Elastomers:	Aluminum	Nitrile	PVDF (Kynar®)	Neoprene	EPDM	Polypropylene	Polyurethane	316 Stainless Steel	PTFE			Encapsulated Silicone	Thermoplastics		(FKM) Fluoroelastomers
									2-Piece	Versa-Tuff™	FUSION™		TPE:XL (Santoprene®)	FDA Hytrel®	
Diaphragms		●		●	●				●	●	●		●	●	●
Valve Balls		●		●	●			●	●	●			●	●	●
Valve Seats	●	●	●	●	●	●	●	●	●	●			●	●	●
Valve Seat O-Rings		●		●	●						●		●		●

CAUTION: Non-metallic pumps and components are not UV stabilized. Ultraviolet radiation can damage these parts and negatively affect material properties. Do not expose to UV light for extended periods of time.

VISIT OUR WEBSITE

- Service videos
- Latest news
- New products
- Digital literature
- Service manuals
- Data sheets
- Chemical Guide app
- And much more...



DOWNLOAD OUR FREE APP



DOWNLOAD APP



- Versa-Matic Pump App**
- Quickly locate pump information
 - Review Chemical Compatibility
 - Flip through the latest literature
 - Watch helpful training videos
 - Access our portal and website



Available for your Android® and Apple® devices.



VERSAMATIC.COM/MOBILEAPPS.ASP

Materials

Material Profile:	Operating Temp:				
	Max.	Min.			
EPDM: Very good water and chemical resistance. Has poor resistance to oils and solvents, but is fair in ketones and alcohols.	280°F 138°C	-40°F -40°C	Polypropylene: A thermoplastic polymer. Moderate tensile and flex strength. Resists strong acids and alkali. Attacked by chlorine, fuming nitric acid and other strong oxidizing agents.	180°F 82°C	32°F 0°C
FKM: (Fluoroelastomers) Shows good resistance to a wide range of oils and solvents; especially all aliphatic, aromatic and halogenated hydrocarbons, acids, animal and vegetable oils. Hot water or hot aqueous solutions (over 70°F) will attack FKM.	350°F 177°C	-40°F -40°C	PVDF: (Polyvinylidene Fluoride) A durable fluoroplastic with excellent chemical resistance. Excellent for UV applications. High tensile strength and impact resistance.	250°F 121°C	0°F -18°C
Hytrel®: Good on acids, bases, amines and glycols at room temperatures only.	220°F 104°C	-20°F -29°C	Santoprene®: Injection molded thermoplastic elastomer with no fabric layer. Long mechanical flex life. Excellent abrasion resistance.	275°F 135°C	-40°F -40°C
Neoprene: All purpose. Resistance to vegetable oils. Generally not affected by moderate chemicals, fats, greases and many oils and solvents. Generally attacked by strong oxidizing acids, ketones, esters and nitro hydrocarbons and chlorinated aromatic hydrocarbons.	200°F 93°C	-10°F -23°C	UHMW PE: A thermoplastic that is highly resistant to a broad range of chemicals. Exhibits outstanding abrasion and impact resistance, along with environmental stress-cracking resistance.	180°F 82°C	-35°F -37°C
Nitrile: General purpose, oil-resistant. Shows good solvent, oil, water and hydraulic fluid resistance. Should not be used with highly polar solvents like acetone and MEK, ozone, chlorinated hydrocarbons and nitro hydrocarbons.	190°F 88°C	-10°F -23°C	Urethane: Shows good resistance to abrasives. Has poor resistance to most solvents and oils.	150°F 66°C	32°F 0°C
Nylon: 6/6 High strength and toughness over a wide temperature range. Moderate to good resistance to fuels, oils and chemicals.	180°F 82°C	32°F 0°C	Virgin PTFE: (PFA/TFE) Chemically inert, virtually impervious. Very few chemicals are known to chemically react with PTFE; molten alkali metals, turbulent liquid or gaseous fluorine and a few fluoro-chemicals such as chlorine trifluoride or oxygen difluoride which readily liberate free fluorine at elevated temp.	220°F 104°C	-35°F -37°C
			<i>Maximum and Minimum Temperatures are the limits for which these materials can be operated. Temperatures coupled with pressure affect the longevity of diaphragm pump components. Maximum life should not be expected at the extreme limits of the temperature ranges.</i>		
			Metals:		
			Stainless Steel: Equal to or exceeding ASTM specification A743 CF-8M for corrosion resistant iron chromium, iron chromium nickel and nickel based alloy castings for general applications. Commonly referred to as 316 Stainless Steel in the pump industry.		

How to Read a Performance Curve

- Select Flow rate (GPM)**
Example: 80 GPM
- Determine Discharge Head (PSI)**
Example: 60 PSI
- See Inlet Air Pressure (PSI)**
Example: 100 PSI
- See Air Consumption (SCFM)**
Example: 80 SCFM

Selection Tip: Size-Up

Size-up your pump to increase energy savings and reduce wear on pump to measurably reduce total cost of ownership.

Contact your distributor or Versa-Matic application engineer for more information:
apptech.warrenrupp@idexcorp.com

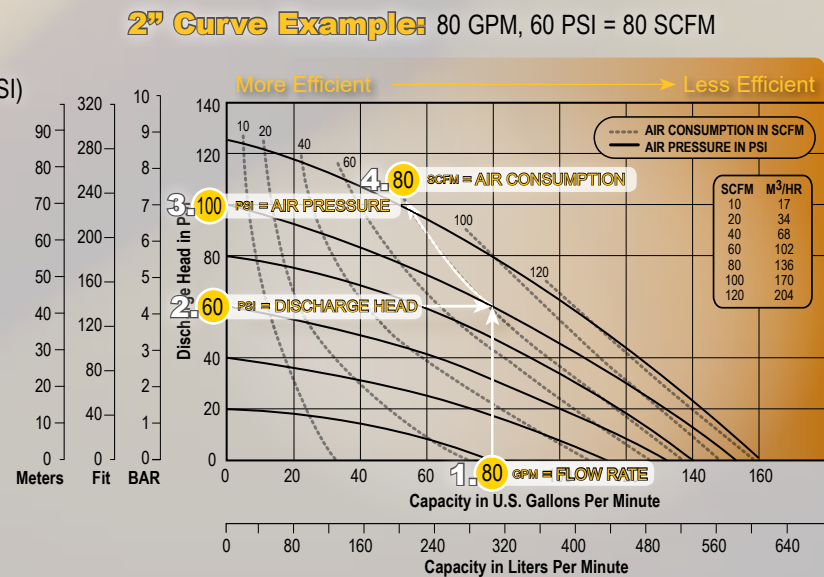

QUALITY ASSURANCE

ALL VERSA-MATIC PUMPS ARE TESTED IN THE FOLLOWING MANNER TO ENSURE A QUALITY BUILT PRODUCT.

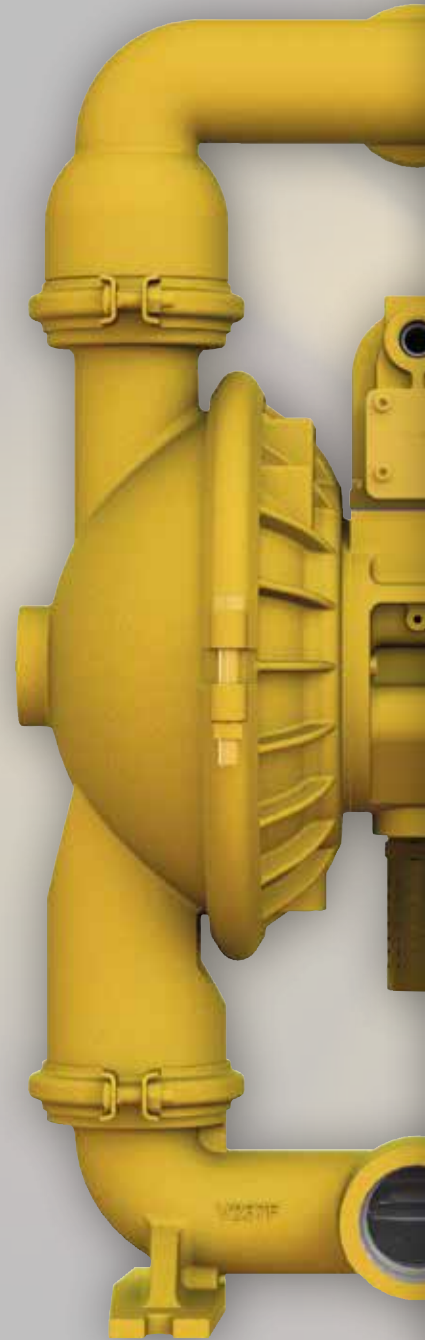

- Dry Cycled Test**
 - Checked for rhythmic cycling
 - Checked for abnormal vibrations
 - Checked for motion abnormalities
- Wet Cycled Test**
 - Checked for dry priming
 - Checked for cycling characteristics
 - Checked for abnormal noise levels
- Vacuum Characteristics Test**
- Dead Head Characteristics Test**
 - Checked for maximum fluid pressure
 - Checked for leakage
 - Checked for valving "By-Pass"
- Comprehensive Visual Inspection**
 - Hardware checked
 - Mating surfaces checked
 - Paint quality checked
 - Packaging checked

REPAIR IT ONCE, REPAIR IT RIGHT

USE COMPLETE KITS INSTEAD OF PARTIAL REPAIRS

- Everything you need in one place
- Reduce frequency of repairs
- Increase service life
- Increase uptime
- Save time and money

Complete Wet and Air Section Repair Kits

Complete Kit vs. Partial Repair

COST OF WET END REPAIR	Partial Repair (1 Diaphragm)	Complete Wet End Repair Kit
Parts:	\$59	\$117
Labor, Down-Time, Lost Product:	\$1,325	\$1,325
Total Estimated Cost per Repair:	\$1,384	\$1,442
Annual Frequency of Repair:	2	1
Estimated Annual Cost:	\$2,768	\$1,442
Estimated Annual Savings*:	\$0	\$1,326

*Example Data: Repair = 1 hour • Pump model #: E4AA1R110C-ATEX • Neoprene wet end • Repair labor rate fully burdened at \$125/hour • Lost product assumes paint



Pump Tags Easily Identify Proper Repair Kits

All new pumps are shipped with convenient Genuine Parts tags to clearly identify proper repair kits. Have a pump without a tag? Visit tags.versamatic.com and order FREE tags.

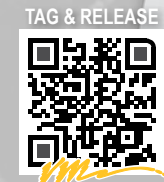

Service Videos

VERSAMATIC.COM/VIDEOS.ASP



VERSA-MATIC®
GENUINE PARTS

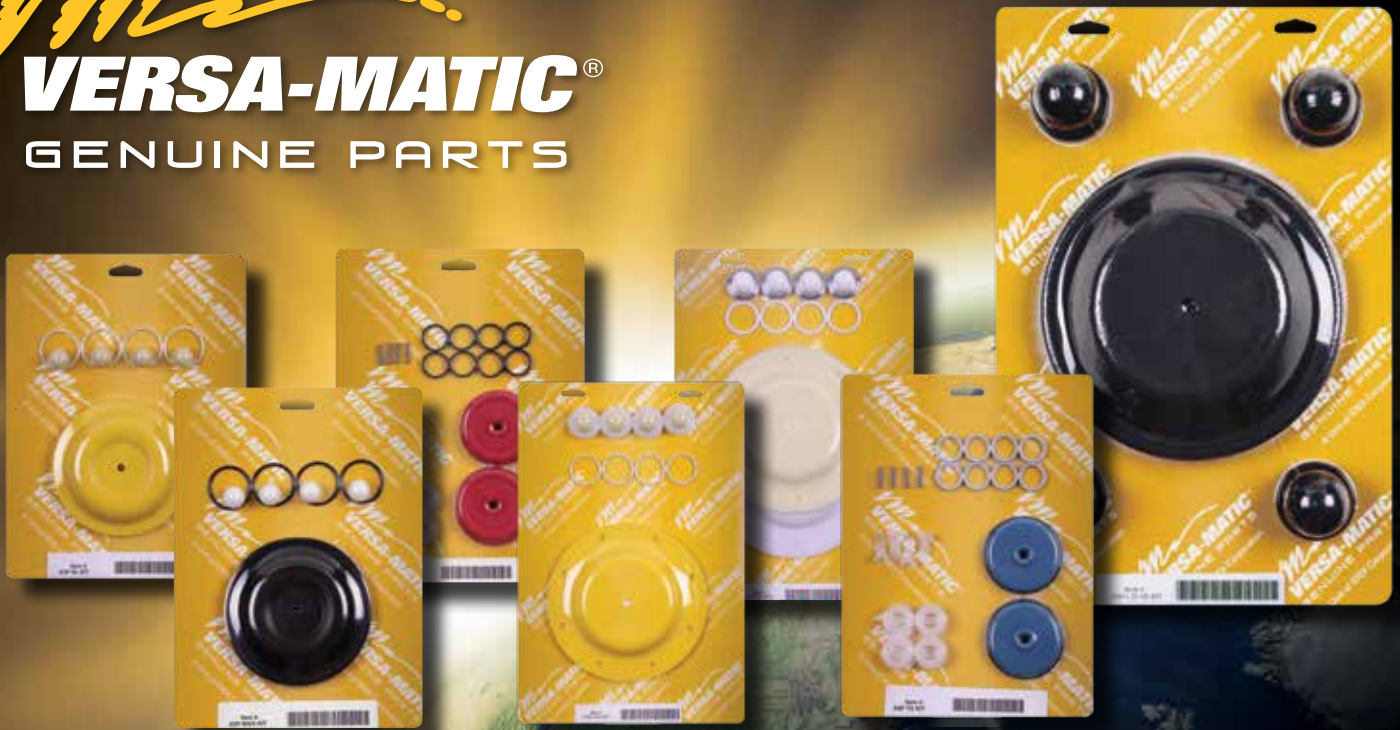

Versa-Matic is Your Global Solutions Provider

Our industry leading worldwide distribution network provides you expert solutions, convenience and support, no matter your location.

5 YEAR
LIMITED
WARRANTY



VERSA-MATIC®
Warren Rupp, Inc. • A Unit of IDEX Corporation
800 North Main Street • Mansfield, OH 44902

Phone: +1 419.526.7296
Fax: +1 419.526.7289
Email: info.versamatic@idexcorp.com
versamatic.com



Distributed By:

©Copyright 2018 Warren Rupp, Inc. All Rights Reserved.

VM_CAT_ProductCatalog_1218